

EMI Measurement Receiver Guide

PSA Series Spectrum Analyzers

Option 239

This manual provides documentation for the following instruments:

Spectrum Analyzers:

E4440A (3 Hz – 26.5 GHz)

E4443A (3 Hz – 6.7 GHz)

E4445A (3 Hz – 13.2 GHz)

E4446A (3 Hz – 44.0 GHz)

E4447A (3 Hz – 42.98GHz)

E4448A (3 Hz – 50.0 GHz)

Systems:

EMI Receiver System



Agilent Technologies

**Manufacturing Part Number: E4440-90625
Supersedes E4440-90330**

Printed in USA

June 2008

© Copyright 2007, 2008 Agilent Technologies, Inc.

The information contained in this document is subject to change without notice.

Agilent Technologies makes no warranty of any kind with regard to this material, including but not limited to, the implied warranties of merchantability and fitness for a particular purpose. Agilent Technologies shall not be liable for errors contained herein or for incidental or consequential damages in connection with the furnishing, performance, or use of this material.

1. Introduction	
What Does the EMI Receiver Do?	10
Installing Optional Measurement Personalities	11
Do You Have Enough Memory to Load All Your Personality Options?	11
How to Predict Your Memory Requirements	13
Loading an Optional Measurement Personality	15
Obtaining and Installing a License Key	15
Viewing a License Key	16
Using the Delete License Key on PSA	16
Ordering Optional Measurement Personalities	17
2. Making Measurements	
Introduction	20
Instrument Requirements	21
Test Equipment Setup	22
Connecting the System	22
Configuring the System	25
Aligning the System	27
Using Instrument Presets Functions.	30
Making Measurements	34
Emissions Measurements With an RF Preselector.	34
File Operation.	44
Saving a Setup file	44
Loading a Setup file	44
Loading a Limit file from the floppy disk	45
Loading a Corrections file from the floppy disk	45
Interpreting Error Codes	46
3. Front-Panel Key and SCPI Command Reference	
Instrument Front Panel Highlights	52
Selected and PSA Front-Panel Features	52
Front-Panel Keys	54
Center Frequency, Span for lower window	54
File	56
Input/ Output	57
Marker Function	58
Meas Control	59
Mode.	60
Mode Setup	61
System	70
Measure	71
Command Interactions: MEASure, CONFigure, FETCh, INITiate and READ	71
Emissions.	74
Measurement Key	75
Emissions Measurement.	75
4. Menu Maps	
EMI Measurement Key Flow.	78

Contents

Directions for Use79

A. Disk Contents: Limit Lines and Transducer Factors

 Limit Line Table98

 Transducer Factors Table103

List of Commands

:CALibration:PRESelector:EXTernal:AB	69
:CALibration:PRESelector:EXTernal:AB[:STATe]?	69
:CALibration:PRESelector:EXTernal:ALL	70
:CALibration:PRESelector:EXTernal:ALL[:STATe]?	70
:CALibration:PRESelector:EXTernal:CD	69
:CALibration:PRESelector:EXTernal:CD[:STATe]?	69
:CALibration:PRESelector:EXTernal:DEFault	70
:CONFigure:EMI	74
:FETCh:EMI[n]?	74
:INITiate:CONTinuous OFF ON	59
:INITiate:EMI	74
:INITiate:PAUSe	60
:INITiate:REStart	59
:INITiate:RESume	60
:INPut:PRESelector[:EXTernal] RF SOURce	57
:INPut:PRESelector[:EXTernal]:PATH FILTer BYPass	57
:INPut:PRESelector[:EXTernal]:PATH?	57
:INPut:PRESelector[:EXTernal]?	57
:INSTrument:NSElect 239	61
:INSTrument:NSElect?	61
:INSTrument[:SElect] SA EMC	60
:INSTrument[:SElect]?	60
:MEASure:EMI:MARKer	58
:MEASure:EMI:MARKer[1] 2 3 4?	58
:MEASure:EMI[n]?	74
:MMEMory:LOAD:SETup <file_name>	56
:MMEMory:STORe:SETup <file_name>	56
:READ:EMI[n]?	74
:SYSTem:COMMunicate:ESource:CONNection LAN LG	66
:SYSTem:COMMunicate:ESource:CONNection?	66
:SYSTem:COMMunicate:ESource:TCONnect	68

List of Commands

:SYSTem:COMMunicate:ESource:TCONnect:TOUT <time>	67
:SYSTem:COMMunicate:ESource:TCONnect:TOUT?	67
:SYSTem:COMMunicate:ESource:TCONnect?	68
:SYSTem:COMMunicate:ESource:TYPE B8648 MXG N5181A N5182A ESG E4438C PSG E8257D	65
:SYSTem:COMMunicate:ESource:TYPE?	65
:SYSTem:COMMunicate:ESource:IDN?	68
:SYSTem:COMMunicate:GPIB:ESource[:EXTeRnal]:ADDReSS <integer>	66
:SYSTem:COMMunicate:GPIB:ESource[:EXTeRnal]:ADDReSS?	66
:SYSTem:COMMunicate:GPIB:ESource[:EXTeRnal]:LUNit <integer>	67
:SYSTem:COMMunicate:GPIB:ESource[:EXTeRnal]:LUNit?	67
:SYSTem:COMMunicate:LAN:ESource[:EXTeRnal]:IP <string>	66
:SYSTem:COMMunicate:LAN:ESource[:EXTeRnal]:IP?	66
:SYSTem:COMMunicate:LAN:PRESelector[:EXTeRnal]:IP <string>	63
:SYSTem:COMMunicate:LAN:PRESelector[:EXTeRnal]:IP?	63
:SYSTem:COMMunicate:PRESelector:IDN?	64
:SYSTem:COMMunicate:PRESelector:TCONnect	64
:SYSTem:COMMunicate:PRESelector:TCONnect:TOUT <time>	64
:SYSTem:COMMunicate:PRESelector:TCONnect:TOUT?	64
:SYSTem:COMMunicate:PRESelector:TCONnect?	64
[:SENSe]:EMI:FREQuency:SPAN	55
[:SENSe]:EMI:FREQuency:SPAN?	55
[:SENSe]:EMI:FREQuency[:CENTer]	54
[:SENSe]:EMI:FREQuency[:CENTer]?	54
[:SENSe]:EMI:MEASure:DETeCtor:AVERAge[:STATe] OFF ON 0 1	75
[:SENSe]:EMI:MEASure:DETeCtor:DWELl <time>	76
[:SENSe]:EMI:MEASure:DETeCtor:DWELl?	76
[:SENSe]:EMI:MEASure:DETeCtor:QPEak[:STATe] OFF ON 0 1 	75
[:SENSe]:FREQuency:PRESelector[:EXTeRnal]:PBANd A B C D CD E UPPer	61
[:SENSe]:FREQuency:PRESelector[:EXTeRnal]:PBANd?	61
[:SENSe]:POWeR[:RF]:PRESelector[:EXTeRnal]:ATTenuation <numeric value>	62

List of Commands

[[:SENSe]:POWer[:RF]:PRESelector[:EXTernal]:ATTenuation?	62
[[:SENSe]:POWer[:RF]:PRESelector[:EXTernal]:GAIN[:STATe] ON OFF 0 1	63
[[:SENSe]:POWer[:RF]:PRESelector[:EXTernal]:GAIN[:STATe]?	63
[[:SENSe]:POWer[:RF]:PRESelector[:EXTernal]:USE YES NO	62
[[:SENSe]:POWer[:RF]:PRESelector[:EXTernal]:USE?	62

List of Commands

1 Introduction

This chapter provides overall information on the Agilent PSA Series EMI Receiver Option 239, and describes the EMI compliance measurements made by the analyzer plus an RF Preselector. Installation instructions for adding this option to your analyzer are provided in this section, if you purchased this option separately.

What Does the EMI Receiver Do?

The EMI Receiver system consists of an Agilent PSA Series Spectrum Analyzer, an Agilent RF Preselector, an Agilent Signal Generator for user alignment, and optional accessories needed to prepare the system for use. Option 239 is an embedded application in the PSA.

The PSA is used as an EMI receiver, controlling the external RF Preselector, to perform CISPR compliance EMI measurements to test conducted and radiated emissions.

Conducted emissions testing focuses on signals, present on the AC mains, that are generated by the equipment under test (EUT). The test range for these measurements is typically from 9 kHz to 30 MHz.

Radiated emissions testing looks for signals broadcasted from the EUT through space. The test range for these measurements is typically from 30 MHz to 1 GHz, depending on the regulation.

You can also perform EMI pre-compliance measurements if you do not have an RF Preselector. PSA EMI measurement keys are not fully functional without the RF Preselector.

Figure 1-1 EMI Receiver System

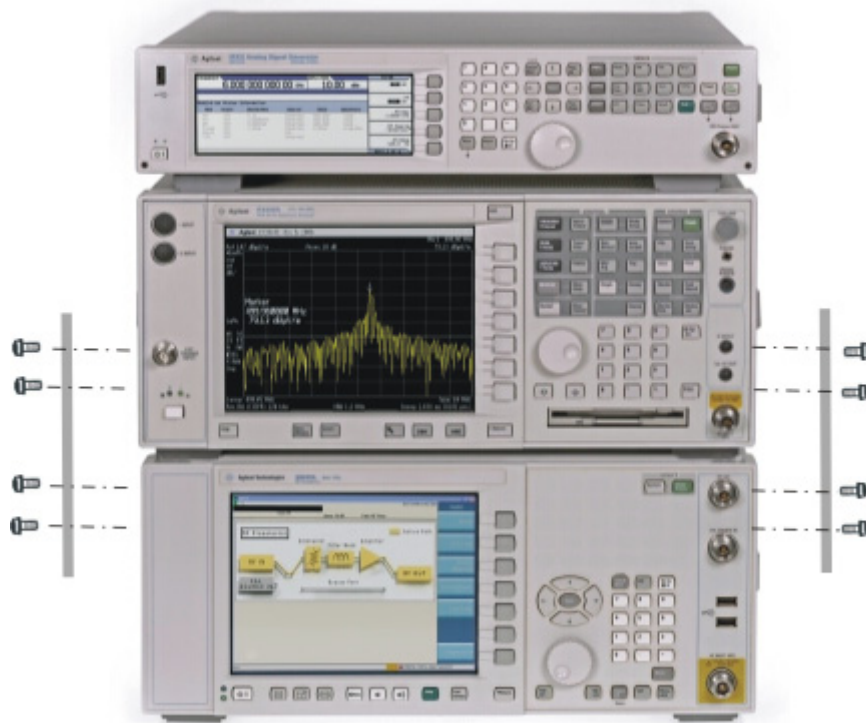

Installing Optional Measurement Personalities

When you install a measurement personality, you need to follow a three step process:

1. Determine whether your memory capacity is sufficient to contain all the options you want to load. If not, decide which options you want to install now, and consider upgrading your memory. Details follow in [“Do You Have Enough Memory to Load All Your Personality Options?”](#) on page 11.
2. Install the measurement personality firmware into the instrument memory. Details follow in [“Loading an Optional Measurement Personality”](#) on page 15.
3. Enter a license key that activates the measurement personality. Details follow in [“Obtaining and Installing a License Key”](#) on page 15.

Adding measurement personalities requires the purchase of an upgrade kit for the desired option. The upgrade kit contains the measurement personality firmware and an entitlement certificate that is used to generate a license key from the internet website. A separate license key is required for each option on a specific instrument serial number and host ID.

For the latest information on Agilent Spectrum Analyzer options and upgrade kits, visit the following web location:

http://www.agilent.com/find/sa_upgrades

Do You Have Enough Memory to Load All Your Personality Options?

If you do not have memory limitations then you can skip ahead to the next section [“Loading an Optional Measurement Personality”](#) on page 15. If after installing your options you get error messages relating to memory issues, you can return to this section to learn more about how to optimize your configuration.

If you have 64 MBytes of memory installed in your instrument, you should have enough memory to install at least four optional personalities, with plenty of memory for data and states.

The optional measurement personalities require different amounts of memory. So the number of personalities that you can load varies. This is also impacted by how much data you need to save. If you are having memory errors you must swap the applications in or out of memory as needed. If you only have 48 MBytes of memory, you can upgrade your

hardware to 64 MBytes.

Additional memory can be added to any PSA Series analyzer by installing Option 115. With this option installed, you can install all currently available measurement personalities in your analyzer and still have memory space to store more state and trace files than would otherwise be possible.

To see the size of your installed memory for PSA Series Spectrum Analyzers:

1. Ensure that the spectrum analyzer is in spectrum analyzer mode because this can affect the screen size.
2. Press **System, Show System**. Under Options look for 115.
3. Press **System, More, Show Hdwr**.
4. Read Flash Memory size in the table.

PSA Flash Memory Size	Available Memory Without Option B7J and Option 122 or 140	Available Memory With Option B7J and Option 122 or 140
64 Mbytes	32.5 MBytes	30.0 MBytes
48 Mbytes	16.9 MBytes	14.3 MBytes

PSA Compact Flash Memory Size	Available Additional Memory for Measurement Personalities
512 Mbytes (Opt. 115)	512 MBytes

If you have 48 MBytes of memory, and you want to install more than 3 optional personalities, you may need to manage your memory resources. The following section, [“How to Predict Your Memory Requirements” on page 13](#), will help you decide how to configure your installed options to provide optimal operation.

How to Predict Your Memory Requirements

If you plan to install many optional personalities, you should review your memory requirements, so you can determine whether you have enough memory (unless you have a PSA Series with Option 115). There is an Agilent “Memory Calculator” available online that can help you do this, or you can make a calculated approximation using the information that follows. You will need to know your instrument’s installed memory size as determined in the previous section and then select your desired applications.

NOTE

If you have a PSA Series analyzer with Option 115, there is adequate memory to install all of the available optional personalities in your instrument.

To calculate the available memory on your PSA, see:
<http://sa.tm.agilent.com/PSA/memory/>

Select the “Memory Calculator” link. You can try any combination of available personalities to see if your desired configuration is compatible with your installed memory.

NOTE

For PSA: After loading all your optional measurement personalities, you should have a reserve of ~2 MBytes memory to facilitate mode switching. Less available memory will increase mode switching time. For example, if you employ excessive free memory by saving files of states and/or data, your mode switching time can increase to more than a minute.

You can manually estimate your total memory requirements by adding up the memory allocations described in the following steps. Compare the desired total with the available memory that you identified in the previous section.

1. Program memory - Select option requirements from the table “Measurement Personality Options and Memory Required” on page 14.
2. The PSA shared libraries require 7.72 MBytes.
3. The PSA recommended mode swap space is 2 MBytes.
4. Screens - .gif files need 20-25 kBytes each.
5. State memory - State file sizes range from 21 kB for SA mode to 40 kB for W-CDMA. The state of every mode accessed since power-on will be saved in the state file. File sizes can exceed 150 kB each when several modes are accessed, for each state file saved.

TIP

State memory retains settings for all states accessed before the **Save State** command. To reduce this usage to a minimum, reduce the modes

accessed before the **Save State** is executed. You can set the PSA to boot into a selected mode by accessing the desired mode, then pressing the **System, Power On/Presets, Power On** keys and toggle the setting to **Last**.

Measurement Personality Options and Memory Required

Personality Options for PSA Series Spectrum Analyzers ^a	Option	File Size (PSA Rev: A.10)
cdmaOne measurement personality	BAC	1.91 Mbytes
NADC and PDC measurement personalities (not available separately)	BAE	2.43 Mbytes
W-CDMA or W-CDMA, HSDPA, HSUPA measurement personality	BAF, 210	5.38 Mbytes ^b
cdma2000 or cdma2000 w/ 1xEV-DV measurement personality	B78, 214	4.00 Mbytes ^b
1xEV-DO measurement personality	204	5.61 Mbytes ^b
GSM (with EDGE) measurement personality	202	3.56 Mbytes ^b
Shared measurement library ^b	n/a	7.72 Mbytes
Phase Noise measurement personality	226	2.82 Mbytes ^c
Noise Figure measurement personality	219	4.68 Mbytes ^c
Basic measurement personality with digital demod hardware	B7J	Cannot be deleted (2.64 Mbytes)
Programming Code Compatibility Suite ^d (8560 Series, 8590 Series, and 8566/8568)	266	1.18 Mbytes ^c
TD-SCDMA Power measurement personality	211	5.47 Mbytes ^c
TD-SCDMA Modulation Analysis or TD-SCDMA Modulation Analysis w/ HSPA measurement personality	212, 213	1.82 Mbytes
Flexible Digital Modulation Analysis	241	2.11 Mbytes ^b
WLAN measurement personality	217	3.24 Mbytes ^b
External Source Control	215	0.72 Mbytes ^c
Measuring Receiver Personality (available with Option 23A - Trigger support for AM/FM/PM and Option 23B - CCITT filter)	233	2.91 Mbytes ^b
EMC Analyzer	239	4.06 Mbytes ^b

a. Available as of the print date of this guide.

- b. Many PSA Series personality options use a 7.72 Mbyte shared measurement library. If you are loading multiple personalities that use this library, you only need to add this memory allocation once.
- c. Shared measurement library allocation not required.
- d. This is a no charge option that does not require a license key.

Memory Upgrade Kits

The PSA 64 MByte Memory Upgrade kit part number is E4440AU-ANE. The PSA Compact Flash Upgrade kit part number is E4440AU-115.

For more information about memory upgrade kits contact your local sales office, service office, or see:

http://www.agilent.com/find/sa_upgrades

Loading an Optional Measurement Personality

You must use a PC to load the desired personality option into the instrument memory. Loading can be done from a firmware CD-ROM or by downloading the update program from the internet. An automatic loading program comes with the files and runs from your PC.

You can check the Agilent internet website for the latest PSA firmware versions available for downloading:

http://www.agilent.com/find/psa_firmware

NOTE

When you add a new option, or update an existing option, you will get the updated versions of all your current options as they are all reloaded simultaneously. This process may also require you to update the instrument core firmware so that it is compatible with the new option.

Depending on your installed hardware memory, you may not be able to fit all of the available measurement personalities in instrument memory at the same time. You may need to delete an existing option file from memory and load the one you want. Use the automatic update program that is provided with the files. Refer to the table showing “[Measurement Personality Options and Memory Required](#)” on page 14. The approximate memory requirements for the options are listed in this table. These numbers are worst case examples. Some options share components and libraries, therefore the total memory usage of multiple options may not be exactly equal to the combined total.

Obtaining and Installing a License Key

If you purchase an optional personality that requires installation, you will receive an “Entitlement Certificate” which may be redeemed for a license key specific to one instrument. Follow the instructions that accompany the certificate to obtain your license key.

To install a license key for the selected personality option, use the following procedure:

NOTE

You can also use this procedure to reinstall a license key that has been deleted during an uninstall process, or lost due to a memory failure.

1. Press **System, More, More, Licensing, Option** to access the alpha editor. Use this alpha editor to enter letters (upper-case), and the front-panel numeric keys to enter numbers for the option designation. You will validate your option entry in the active function area of the display. Then, press the **Enter** key.
2. Press **License Key** to enter the letters and digits of your license key. You will validate your license key entry in the active function area of the display. Then, press the **Enter** key.
3. Press the **Activate License** key.

Viewing a License Key

Measurement personalities purchased with your instrument have been installed and activated at the factory before shipment. The instrument requires a **License Key** unique to every measurement personality purchased. The license key is a hexadecimal number specific to your measurement personality, instrument serial number and host ID. It enables you to install, or reactivate that particular personality.

Use the following procedure to display the license key unique to your personality option that is already installed in your PSA:

Press **System, More, More, Licensing, Show License**. The **System, Personality** key displays the personalities loaded, version information, and whether the personality is licensed.

NOTE

You will want to keep a copy of your license key in a secure location. Press **System, More**, then **Licensing, Show License** and print out a copy of the display that shows the license numbers. If you should lose your license key, call your nearest Agilent Technologies service or sales office for assistance.

Using the Delete License Key on PSA

This key will make the option unavailable for use, but will not delete it from memory. Write down the 12-digit license key for the option before you delete it. If you want to use that measurement personality later, you will need the license key to reactivate the personality firmware.

NOTE

Using the **Delete License** key does not remove the personality from the instrument memory, and does not free memory to be available to install another option. If you need to free memory to install another option,

refer to the instructions for loading firmware updates located at the URL : <http://www.agilent.com/find/psa/>

1. Press **System, More, More, Licensing, Option**. Pressing the **Option** key will activate the alpha editor menu. Use the alpha editor to enter the letters (upper-case) and the front-panel numeric keyboard to enter the digits (if required) for the option, then press the **Enter** key. As you enter the option, you will see your entry in the active function area of the display.
2. Press **Delete License** to remove the license key from memory.

Ordering Optional Measurement Personalities

When you order a personality option, you will receive an entitlement certificate. You will need to go to the Web site to redeem your entitlement certificate for a license key. You will need to provide your instrument serial number and host ID, and the entitlement certificate number.

Required Information:	Front Panel Key Path:
Model #: (Ex. E4440A)	
Host ID: _____	System, Show System
Instrument Serial Number: _____	System, Show System

2

Making Measurements

This chapter describes instructions to help you set up the system, procedures to perform the measurements of signals, and examples of measurement results for EMC analysis.

Introduction

All the keys and SCPI commands have the same function as those under **Meas Off** in the **Spectrum Analysis** mode unless stated in the following sections. Refer to *PSA User's and Programmer's Reference* for more details.

The following subjects are presented in this chapter:

- “Instrument Requirements” on page 21
- “Test Equipment Setup” on page 22
- “Making Measurements” on page 34
- “File Operation” on page 44
- “Interpreting Error Codes” on page 46

Instrument Requirements

The following are required:

- PSA Series Spectrum Analyzer
 - PSA Serial Prefix of US4430, MY4430, SG4430, or above
 - PSA Firmware A.10.xx or later
 - PSA Option 239 EMI Measurement Receiver
- One of the following signal generators
 - N5181A MXG
 - N5182A MXG
 - E4438C ESG
 - E8257D PSG
 - 8648B (a LAN/GPIB gateway is required, or you can order Option 011)
- N9039A RF Preselector
- One of following options to connect the RF Preselector to the PSA
 - N9039A-019 — Type-N to Type-N
 - N9039A-027 — APC 3.5 mm to APC 3.5 mm (for PSA Option BAB)
 - N9039A-030 — APC 3.5 mm to APC 2.4 mm (for PSA Model Number E4446A/E4447A/E4448A)
- One of following LAN connectivity options (optional, if your instrument have access to an existing network)
 - N9039A-010 — Ethernet hub and 3 shielded LAN cables
 - N9039A-011 — LAN/GPIB Gateway and GPIB cable, Ethernet hub and 3 shielded LAN cables

Test Equipment Setup

CAUTION Before connecting a signal to the instrument, make sure the instrument can safely accept the signal level provided. The signal level limits are marked next to the connectors on the front panel.

NOTE Before you can begin making measurements, make sure you have Option 239 application firmware installed.

If you have purchase a new PSA, Option 239 was installed at the factory. If you purchased Option 239 as an upgrade to be installed in a pre-existing PSA, refer to [“Installing Optional Measurement Personalities” on page 11](#).

Connecting the System

Stack the instruments and attached the support brackets as shown in the *EMI Measurement Receiver Quick Start Guide*. Use appropriate cables to connect the system hardware as shown in [Figure 2-1, “Hardware Connections - Emissions Measurement System”](#). Use the provided LAN cables to connect the PSA, source, and RF Preselector to the Hub.

If you are using a source that does not have a LAN port (8648B), use a GPIB cable to connect your source to a LAN/GPIB gateway (N5810A), and use the provided LAN cables to connect the gateway, PSA, and RF Preselector to the Hub. See [Figure 2-2, “Hardware Connections - Using LAN/GPIB Gateway”](#).

If you are using only a PSA to perform pre-compliance measurements, connect the system as shown in [Figure 2-3, “Hardware Connections - Using PSA only”](#).

NOTE If you are using the RF Preselector, make sure you have connected the EXT TRIGGER INPUT (front panel) and the TRIGGER 2 IN (rear panel) of the PSA to the RF Preselector. See [Figure 2-1, “Hardware Connections - Emissions Measurement System”](#) and [Figure 2-2, “Hardware Connections - Using LAN/GPIB Gateway”](#).

Figure 2-1 Hardware Connections - Emissions Measurement System

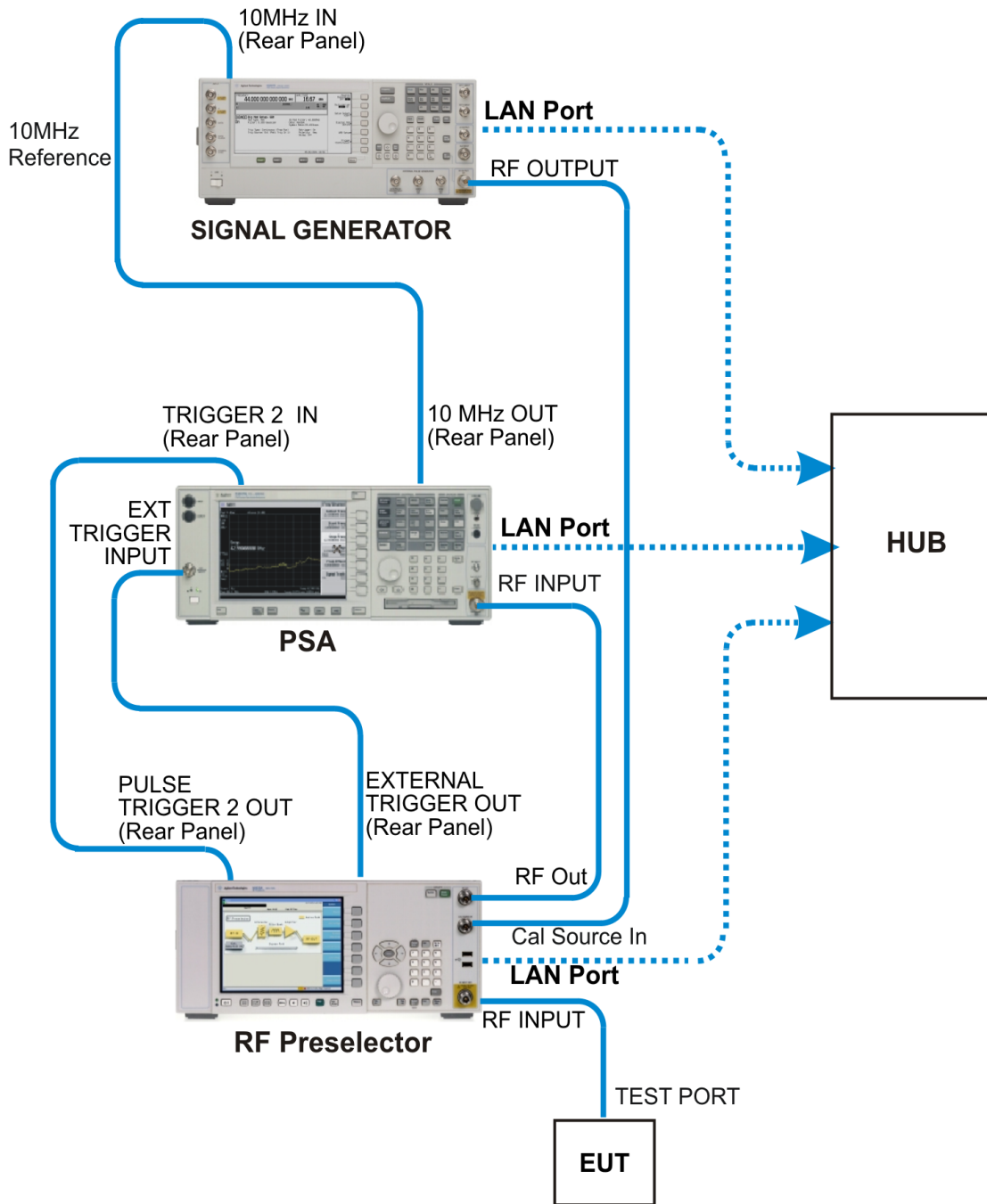

Figure 2-2 Hardware Connections - Using LAN/GPIB Gateway

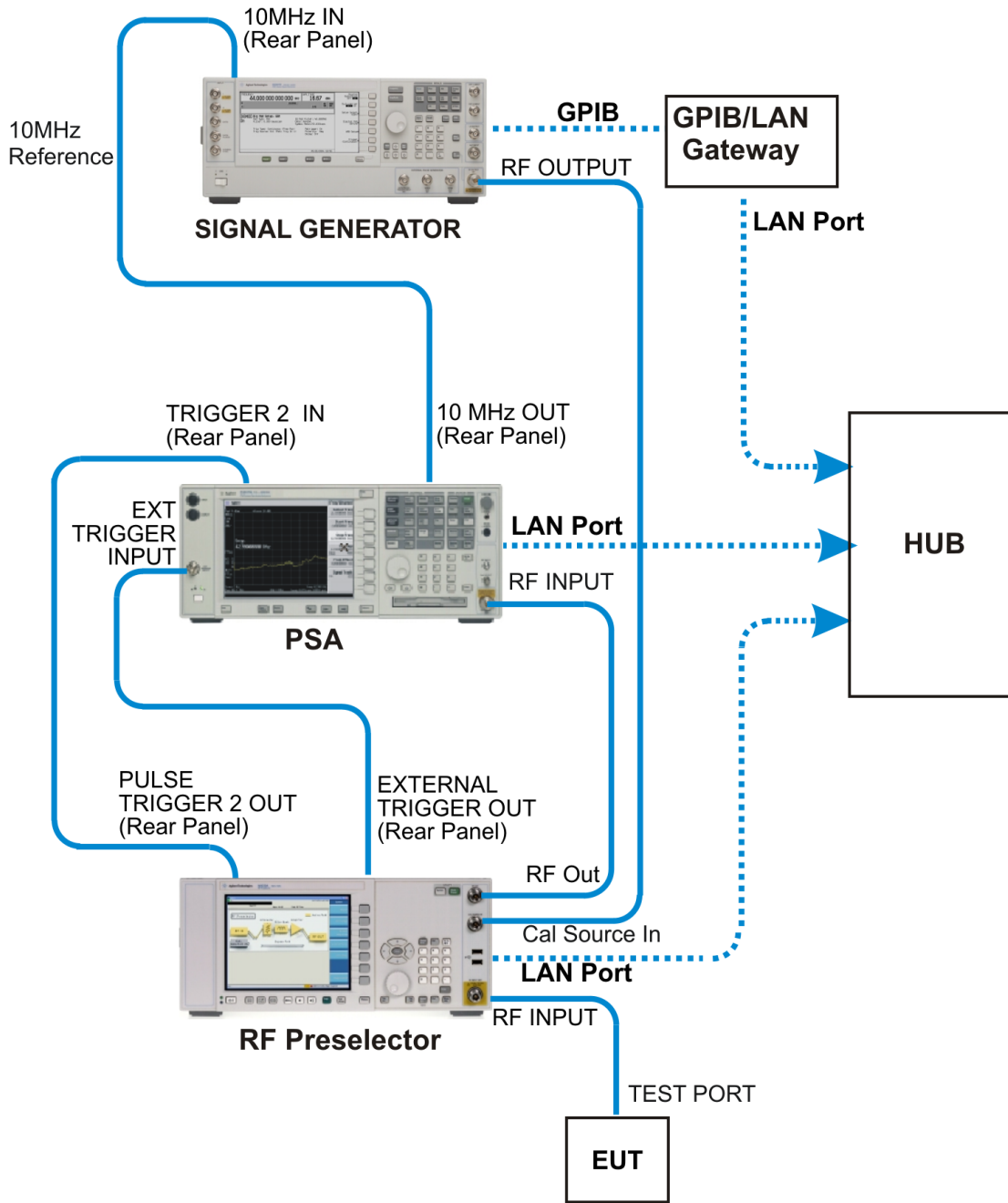

Figure 2-3 Hardware Connections - Using PSA only



Configuring the System

The following steps describe how to configure the PSA to recognize the RF Preselector and source. The source is used only for system alignment. Once the system alignment is done, you can disconnect the source.

- Step 1.** Connect the instruments and apply power to them. See [“Connecting the System” on page 22](#). Ensure the instruments have an adequate warm-up time.

Configure the IP address of the RF Preselector and source, respectively. Refer to the *RF Preselector User’s and Programmer’s Guide*.

You may need to press the **Local** key on the source to activate front panel access if it was controlled remotely.

- Step 2.** On the PSA, press **System, Config I/O** to access the I/O configuration menu for the PSA:

- Press **IP Address**, enter the PSA IP address, and press **Enter**.
- Press **Subnet Mask**, enter the subnet mask, and press **Enter**.
- Press **Gateway Address**, enter the network gateway address, and press **Enter**.

NOTE Consult your IT support if you have questions about the IP address, subnet mask, or gateway address.

- Step 3.** Press **MODE, EMC Analyzer** to select the desired mode.

- Step 4.** Press **Mode Setup, Config EMI Receiver, RF Presel Config** to access the configuration menu for the RF Preselector.

- Press **IP Address**, enter the IP address for the RF Preselector, and press **Enter**.
- Press **Time Out** to adjust the time that the PSA needs to connect to the RF Preselector. The default setting is 10 s.

- Press **Verify RF Presel Connection** to verify the connection between the PSA and RF Preselector.

NOTE

If you do not see any connection error messages, the connection to the RF Preselector has been established. Ignore the alignment required message at this time.

Step 5. Press **Mode Setup, Config EMI Receiver, Source Config** to access the configuration menu for the source.

- Press **Model Number** and select the signal generator model number that you are using. The **Conn Mode** will be automatically set according to the selected model number.
- Press **IP Address**, enter the IP address for the source, and press **Enter**.

If you select the 8648B as the model number,

- Press **IP Address** and enter the IP address for the LAN/GPIB Gateway.
- Press **GPIB Address** and enter GPIB Address for the source.
- Press **Logic Unit** and enter the GPIB Gateway Logic Unit for the signal generator.
- Press **Time Out** to adjust the time that the PSA needs to connect to the signal generator.
- Press **Verify Source Connection** to verify the connection between the PSA and source.

NOTE

If you do not see any connection error messages, the connection to the signal source has been established. Ignore the alignment required message at this time.

Step 6. Press **Mode Setup, Config EMI Receiver, Show Config** to display and confirm the system configuration information. You will get the following screen.

Figure 2-4 Show Config Screen

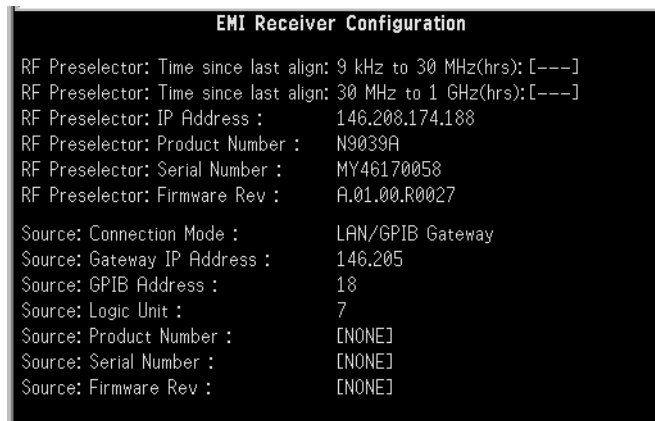

Aligning the System

NOTE

Before performing any Emissions measurement, a system alignment is required.

During the alignment, the front panel keys are locked. If you want to abort the alignment, press the **ESC** key.

The following steps describe how to perform the alignment for the RF Preselector:

- Step 1.** If you get the following message on the PSA screen, press **System, Alignments, Align All Now** to perform the PSA alignment.

Figure 2-5 PSA Alignment Needed

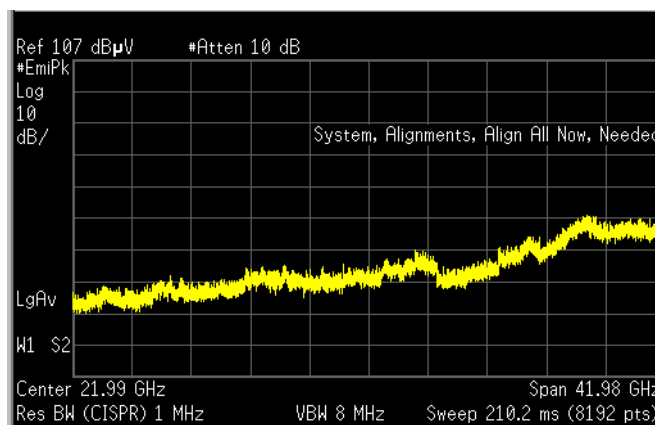

Step 2. Press **Mode Setup**, **Align RF Presel** to display the Alignment menu for the RF Preselector. Select the desired signal band from one of the following options:

- Align 9 kHz to 30 MHz
- Align 30 MHz to 1 GHz
- Align 9 kHz to 1 GHz

For conducted measurements, you need to align 9 kHz to 30 MHz.

For radiated measurements, you need to align 30 MHz to 1 GHz.

Wait until the alignment is done. This can take up to 25 minutes. Once the alignment is done, the system is ready for use.

Pressing **Restore Presel Align Default** will restore the RF Preselector factory calibration data to both the conducted and radiated bands. If you restore the defaults, you will need to perform the alignment again.

NOTE

Anytime you get one of the following warning or error messages, perform the respective alignment.

- PreselCondAlign — press **Align 9 kHz to 30 MHz** or **Align 9 kHz to 1 GHz**
- PreselRadAlign — press **Align 30 MHz to 1 GHz** or **Align 9 kHz to 1 GHz**
- Conducted Align failed — press **Align 9 kHz to 30 MHz** or **Align 9 kHz to 1 GHz**
- Radiated Align failed — press **Align 30 MHz to 1 GHz** or **Align 9 kHz to 1 GHz**
- Connection failed — see [“Configuring the System” on page 25](#) and [“Aligning the System” on page 27](#).

The following examples show alignment failures that require you to perform the alignment again.

Figure 2-6 Example of Alignment Needed (conducted and radiated)

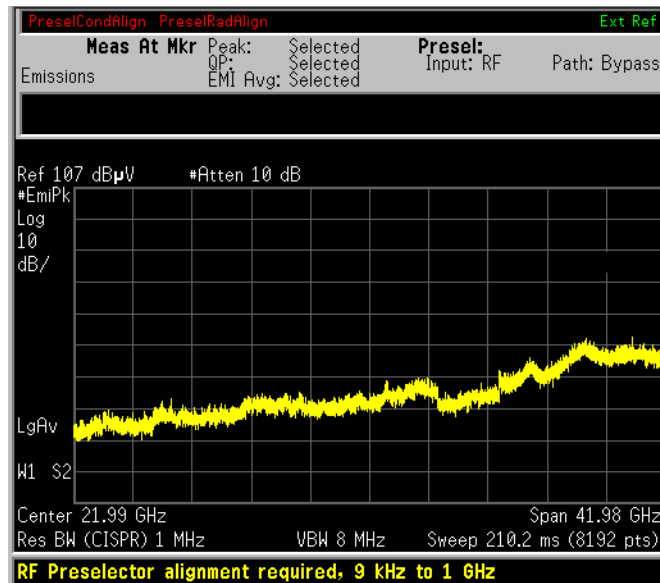

Figure 2-7 Example of Alignment Failure (conducted)

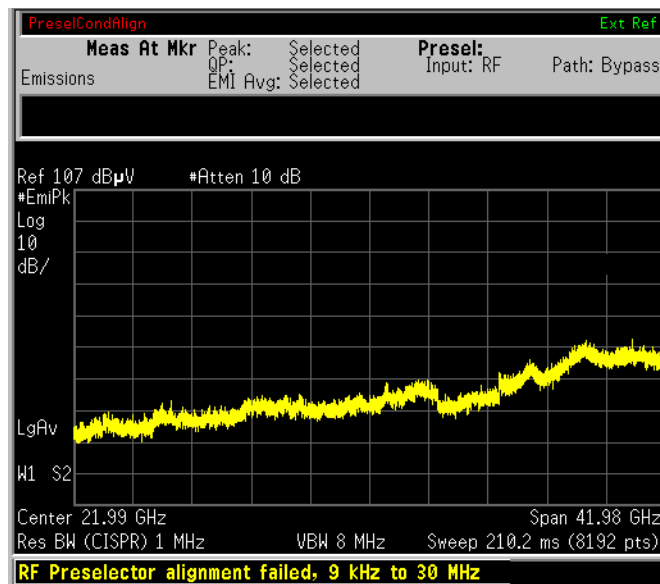
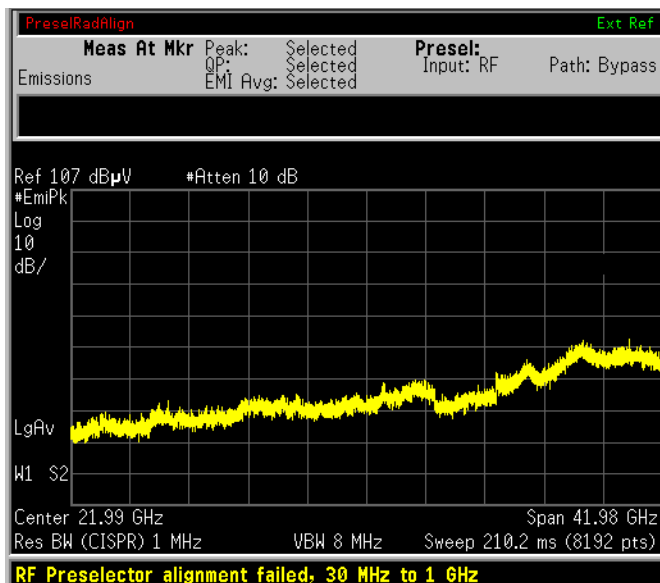

Figure 2-8 Example of Alignment Failure (radiated)



For more warning messages or error information, see “[Interpreting Error Codes](#)” on page 46.

Using Instrument Presets Functions

Factory Preset

When the Power On/Preset function **Preset Type** is set to **Factory** and you want to set your current measurement personality to a known, factory default state, press **Preset**. This initializes the instrument by returning the mode setup and all of the measurement setups in the mode to the factory default parameters.

NOTE Pressing the **Preset** key may switch instrument modes if you have set the Power On/Preset function Preset Type to Factory.

Table 2-1 PSA Model Numbers and Frequency Ranges

Model	Factory Preset Stop Frequency with Preselector enabled
E4440A (3Hz to 26.5GHz)	26.5GHz
E4443A (3Hz to 6.7GHz)	6.7GHz
E4445A (3Hz to 13.2GHz)	13.2GHz
E4446A (3Hz to 44GHz)	44GHz
E4447A (3Hz to 42.98GHz)	42.98GHz
E4448A (3Hz to 50GHz)	50GHz

Table 2-2 Factory Preset Settings

Parameters	Default settings
Mode Setup/EMI Presets	1 GHz — Above
Mode Setup/Use RF Presel	No
Meas Setup/Meas At Marker Detector/Quasi Peak	On
Meas Setup/Meas At Marker Detector/EMI Averages	On
Meas Setup/Dwell Time	200.0 ms
Mode Setup/RF Presel Att	10 dB (grayed-out)
Mode Setup/RF Presel Gain	Off (grayed-out)
Input/Output /Presel Input	RF (grayed-out)
Input/Output /Presel Path	Bypass (grayed-out)
Detector	EMI Peak
Res BW	1 MHz (CISPR)
Span	depends on PSA model ^a
Center Frequency	depends on PSA model ^b
Start Freq	1 GHz
Stop Freq	depends on PSA model ^c
AMPLITUDE Y Scale/Y Axis Unit	dBuV
AMPLITUDE Y Scale/Ref Level	106.99 dBuV
Sweep Time	Auto
Gate	Off
Sweep Points	8192
AMPLITUDE Y Scale/Attenuation	10 dB

- a. Span = Stop Frequency – 1 GHz
- b. Center Frequency = 1 GHz + Span/2
- c. See [Table 2-1, “PSA Model Numbers and Frequency Ranges.”](#)

Mode Preset

When the Power On/Presel function Preset Type is set to Mode and you want to set your current measurement personality to a known, mode default state, press **Preset**. This initializes the instrument by returning the mode setup and all of the measurement setups in the mode to the mode default parameters.

Table 2-3 Mode Preset Settings

Parameters	Default settings
Mode Setup/EMI Presets	1 GHz — Above
Mode Setup/Use RF Presel	The previous state ^{a,b}
Meas Setup/Meas At Marker Detector/Quasi Peak	On
Meas Setup/Meas At Marker Detector/EMI Averages	On
Meas Setup/Dwell Time	200.0 ms
Mode Setup/RF Presel Att	10 dB
Mode Setup/RF Presel Gain	Off
Input/Output /Presel Input	RF ^c
Input/Output /Presel Path	Bypass ^d
Detector	EMI Peak
Res BW	1 MHz (CISPR)
Span	depends on PSA model ^e
Center Frequency	depends on PSA model ^f
Start Freq	1 GHz
Stop Freq	depends on PSA model ^g
AMPLITUDE Y Scale/Y Axis Unit	dBuV
AMPLITUDE Y Scale/Ref Level	106.99 dBuV
Sweep Time	Auto
Gate	Off
Sweep Points	8192
AMPLITUDE Y Scale/ Attenuation	10 dB

- a. If the PSA cannot communicate to the RF Preselector, **Use RF Presel** will be set to **No**.
- b. If you cycle the PSA power, **Use RF Presel** will be set to **No**.

- c. If **Use RF Presel** is set to **No**, **Presel Input** will be unavailable (grayed-out).
- d. If **Use RF Presel** is set to **No**, **Presel Path** will be unavailable (grayed-out).
- e. $\text{Span} = \text{Stop Frequency} - 1 \text{ GHz}$
- f. $\text{Center Frequency} = 1 \text{ GHz} + \text{Span}/2$
- g. See [Table 2-1, “PSA Model Numbers and Frequency Ranges.”](#)

NOTE

All the parameter settings in the **Config EMI Receiver** menu will not change when you cycle the PSA power or press **Preset**.

Making Measurements

CAUTION

Before connecting a signal to the instrument, make sure the instrument can safely accept the signal level provided. The signal level limits are marked next to the connectors on the front panel.

Once the system alignment is done, you can perform Emissions measurements.

Emissions Measurements With an RF Preselector

Table 2-4 The default values when the EMI Presets key is pressed for a full-compliance measurement

Band Setup	Band A	Band B	Band C	Band D	Band C&D	Band E	Above 1GHz
Start Frequency	9kHz	150kHz	30MHz	300MHz	30MHz	1GHz	1GHz
Stop Frequency	150kHz	30MHz	300MHz	1GHz	1GHz	18 GHz	See Table 2-1
Sweep Point	706	3318	2251	5835	8085	8192	8192
RBW	200Hz	9kHz	120kHz	120kHz	120kHz	1MHz	1MHz
Detector	EMI Peak	EMI Peak	EMI Peak	EMI Peak	EMI Peak	EMI Peak	EMI Peak
Y Axis Units	dB μ V	dB μ V	dB μ V	dB μ V	dB μ V	dB μ V	dB μ V
PSA Attenuation	10dB	10dB	10dB	10dB	10dB	10dB	10dB
Ref Level	70 dB μ V	75 dB μ V	80 dB μ V	80 dB μ V	80 dB μ V	107 dB μ V	107 dB μ V
Preselector Attenuation	10dB	10dB	10dB	10dB	10dB	10dB	10dB
Preselector Gain	Off	Off	Off	Off	Off	Off	Off

Conducted Emissions Measurements

- Step 1.** Complete the EMI Receiver system connections, system configuration, and system alignment. See “Connecting the System” on page 22, “Configuring the System” on page 25 and “Aligning the System” on page 27.

Figure 2-9 Conducted Measurement System Example

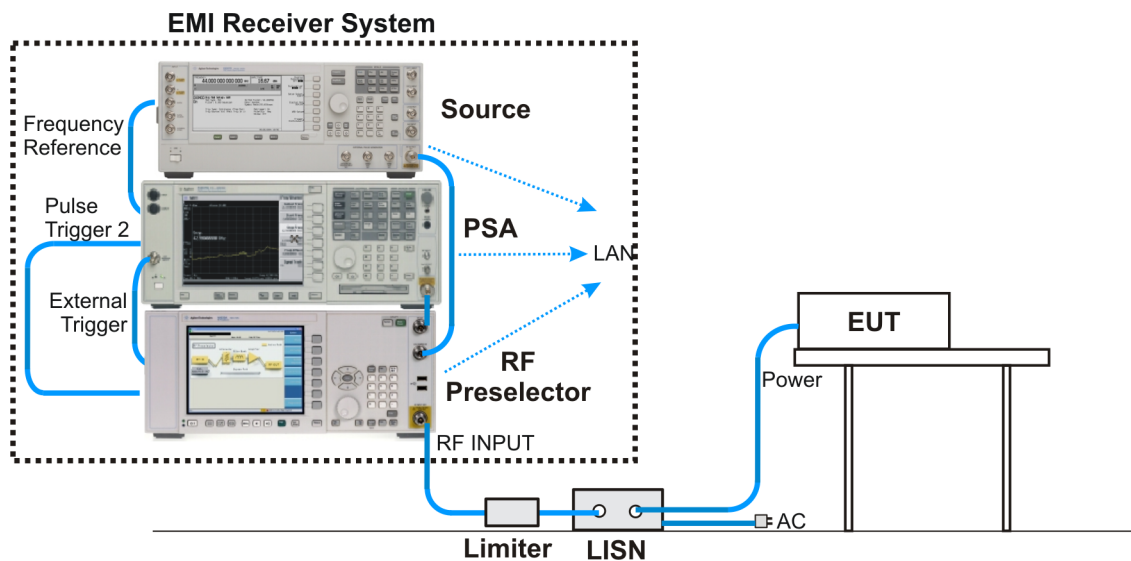

- Step 2.** Turn on the EUT power.

Connect the EUT to the EMI Receiver system using the appropriate accessories, such as an 11947A Transient, limiter and LISN, as shown in Figure 2-9, “Conducted Measurement System Example”.

- Step 3.** Press **MODE, EMC Analyzer** to select the desired mode.
Step 4. Press **Mode Setup** and toggle **Use RF Presel** to **Yes**.

NOTE The **Use RF Presel** key cannot be set to **Yes** when the PSA cannot communicate with the RF Preselector.

- Step 5.** Press **Input/Output, Presel Path** to ensure the **Filter** path is selected.

NOTE The **Presel Path** key is unavailable (grayed-out) when **Use RF Presel** is set to **No**.

If you manually set a signal frequency below 20 MHz you will get a warning message “AC Coupled: unspecified below 20 MHz”. Press **Input/Output** and toggle **RF Coupling** to **DC**. The message will disappear.

NOTE If you switch to **Spectrum Analysis** mode, the **Presel Path** will

automatically be changed to **Bypass**.

Step 6. Press **Mode Setup**, **EMI Presets**, and select the desired band, such as **CISPR B 150 kHz - 30 MHz**.

Step 7. If you get a message of “RF Presel input is overloaded”, press **RF Presel Att** to increase the attenuation of the RF Preselector.

NOTE The **RF Presel Att** key is unavailable (grayed-out) when **Use RF Presel** is set to **No**, or **Presel Path** is set to **Bypass**.

When you change the attenuation setting on the RF Preselector, the PSA reference level display may change accordingly.

When **Presel Path** is set to **Filter**, the system attenuation only includes the RF Preselector attenuator although the PSA has a 10 dB fixed attenuation.

When **Presel Path** is set to **Bypass**, the system attenuation is what you set on the PSA.

Step 8. To load limit lines for the most common standards, as well as typical correction factors for a wide variety of measurement transducers, insert the provided floppy disk of *Limit Lines and Transducer Factors* into the floppy disk drive on the PSA and load the desired files for your test. For more information, see “[File Operation](#)” on page 44 and [Appendix A](#), “[Disk Contents: Limit Lines and Transducer Factors](#),” on page 101.

- Select **Limits** as the type for loading the Limit Lines files.
- Select **Corrections** as the type for loading the Transducer Factors files.

NOTE After loading correction factors for antennas, verify that the reference level unit is set to dB μ V/m

Once the limits have been loaded, **Limit Display** will automatically be set to **On** and the limit line will be displayed on the screen.

Step 9. Press **Display**, **Limits**, **Limit 1**, toggle **Limit Test** to **On**. For more information about using the **Display** function, see the *PSA User’s and Programmer’s reference*.

CAUTION To avoid damaging the input of the EMC Receiver do not make the connection to the RF Input of the RF Preselector until the EUT power has been turned on, and do not change the state of the EUT power, or the LISN output, while the input is connected, without the use of an input limiter, such as the 11947A.

Step 10. Switch the power of the EUT off and check the display to ensure the

noise floor is at least 10 dB below the limit line.

If the noise floor is less than 10 dB below the limit line, toggle **RF Presel Gain** to **On** to improve the noise floor versus limit line.

NOTE **RF Presel Gain** is unavailable (grayed-out) when **Use RF Presel** is set to **No**, or **Presel Path** is set to **Bypass**.

Figure 2-10 **RF Presel Gain Off**

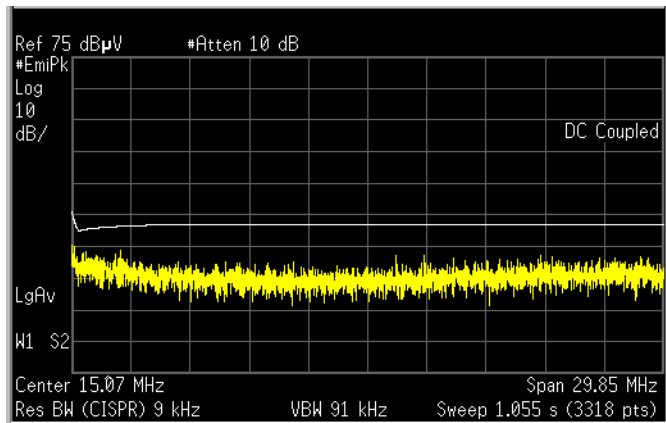
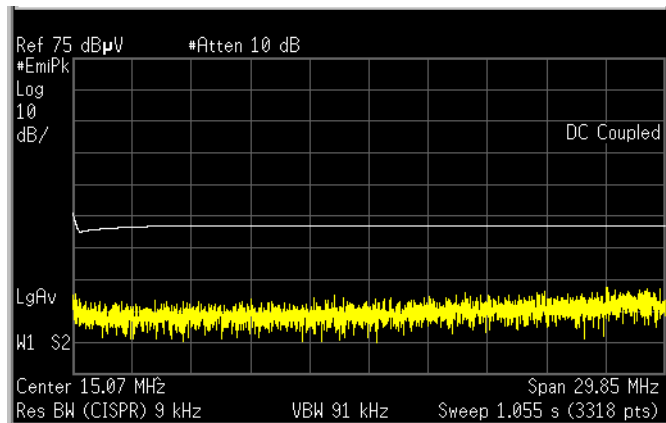

Figure 2-11 **RF Presel Gain On**



Step 11. On the PSA screen, the PASS/FAIL indicator will show “PASS LIMIT1” in green color when the peak value of all signals present are below the regulatory limit, or “FAIL LIMIT1” in red color when the signal exceeds the limit being used.

Figure 2-12 PASS Indicator

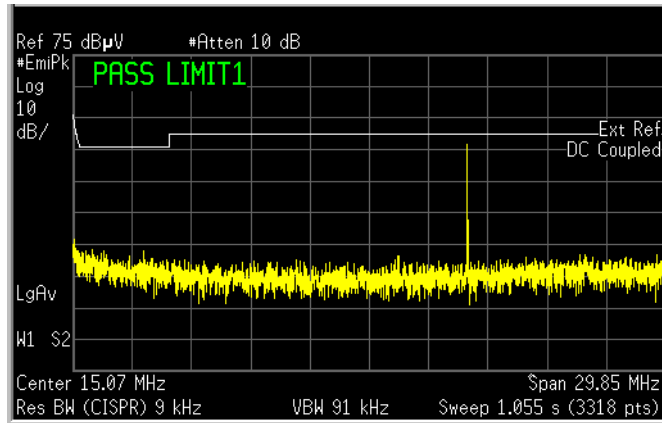
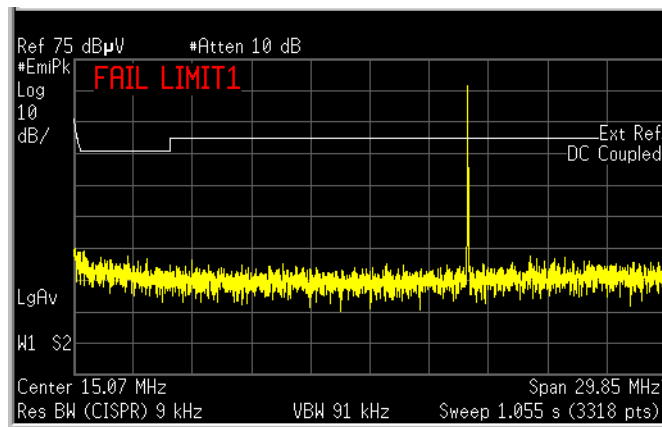

Figure 2-13 FAIL Indicator



Step 12. To analyze signals further, press Zoom to split the screen to show two windows:

- The upper window is the previous full-screen window, displaying a full-trace.
- The lower window displays a portion of the trace.

Figure 2-14 **Zoomed Screen**

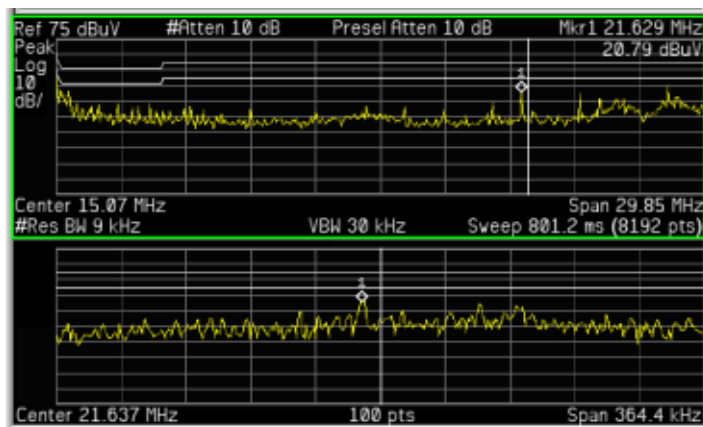

Step 13. Press **Next Window** to toggle to the lower window. The green outlined window is the active window.

Figure 2-15 **Next Window**

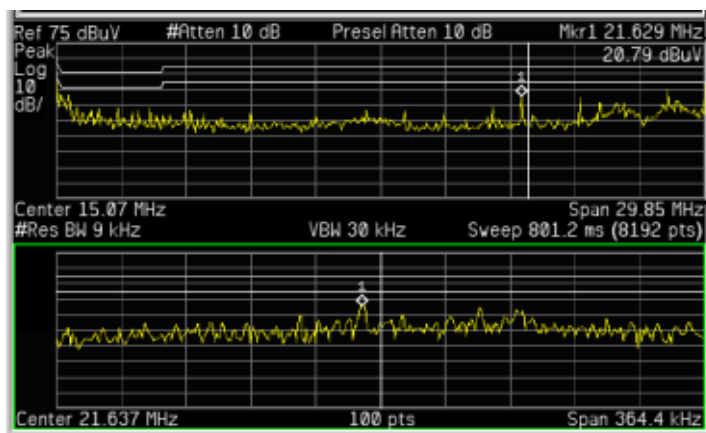

Step 14. Press **Center Frequency** to set the desired center frequency in the lower window. The value of the center frequency will be automatically coupled according to the data trace captured.

When you change the center frequency in the lower window, a vertical positioning indicator in the upper window will move accordingly.

Step 15. Press **SPAN X Scale, Span** to change the span. The number of the displayed data points in the lower window will be changed accordingly. Around the selected frequency, a minimum of 11 data points and a maximum of 462 data points will be displayed.

Step 16. Press **Meas Setup, Meas at Mkr Detector**, you can select or remove the detectors to be used to further analyze signals of interest.

Toggle **Quasi Peak** to **On** or **Off**.

Toggle **EMI Average** to **On** or **Off**.

Figure 2-16 Removing the Quasi Peak and EMI Average Detectors

Meas At Mkr	Peak: Selected	Presel:	
Emissions	QP: Not Selected	Input: RF	Path: Bypass
	EMI Avg: Not Selected		

Figure 2-17 Selecting the Detectors

Meas At Mkr	Peak: Selected	Presel:	
Emissions	QP: Selected	Input: RF	Path: Filter
	EMI Avg: Selected	Atten: 10 dB	Gain: OFF

- Step 17.** To adjust the measurement dwell time, press **Meas Setup, Dwell Time** and set the desired time.
- Step 18.** To analyze individual signals, place a marker on the signal of interest and press **Marker Fctn, Measure at Marker** to perform a measurement of that signal.

Figure 2-18 Measure at Marker Results

Meas At Mkr	Peak: 59.12 dBuV	Presel:	
Emissions	QP: 58.51 dBuV	Input: RF	Path: Bypass
	EMI Avg: 58.23 dBuV		

For more information about using the Marker functionality, see the *PSA User's and Programmer's Reference*.

- Step 19.** Repeat the measurement procedure until all of the signals greater than or equal to the limit line have been measured and record the measurement results.

Radiated Emissions Measurements

- Step 1.** Complete the system connections, system configuration and system alignment. See “Connecting the System” on page 22, “Configuring the System” on page 25 and “Aligning the System” on page 27.

Figure 2-19 Radiated Measurement System Example

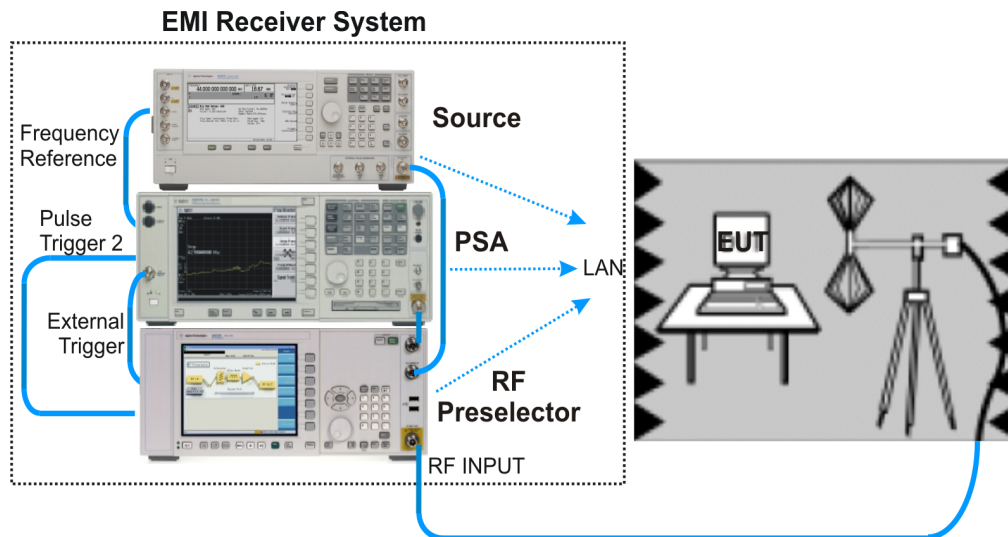

- Step 2.** Connect the EUT to the EMI Receiver system using the appropriate accessories and antenna, as shown in “Radiated Measurement System Example” on page 41.
- Step 3.** Press **Mode, EMC Analyzer** to select the desired mode.
- Step 4.** Press **Mode Setup** and toggle **Use RF Presel** to **Yes**.
- Step 5.** Press **Input/Output, Presel Path** to ensure the **Filter** path is selected.

NOTE The **Presel Path** key is unavailable (grayed-out) when **Use RF Presel** is set to **No**.

Before you switch to **Spectrum Analysis** mode, make sure **Presel Path** is set to **Bypass**.

- Step 6.** Press **Mode Setup, EMI Presets**, and select the desired band, such as **CISPR D 300 MHz to 1 GHz**.
- Step 7.** Turn on the EUT power and sweep the frequency range of interest.
- Step 8.** If you get a message of “RF Presel input is overloaded”, press **RF Presel Att** to increase the attenuation of the RF Preselector.

NOTE This key is unavailable (grayed-out) when **Use RF Presel** is set to **No**, or **Presel Path** is set to **Bypass**.

When you change the attenuation setting on the RF Preselector, the PSA reference level display may change accordingly.

When **Presel Path** is set to **Filter**, the system attenuation only includes the RF Preselector attenuator although the PSA has a 10 dB fixed attenuation.

When **Presel Path** is set to **Bypass**, the system attenuation is what you set on the PSA.

Step 9. To load limit lines for the most common standards, as well as typical correction factors for a wide variety of measurement transducers, insert the provided floppy disk of *Limit Lines and Transducer Factors* into the floppy disk drive on the PSA and load the desired files for your test. For more information, see “[File Operation](#)” on page 44 and [Appendix A](#), “[Disk Contents: Limit Lines and Transducer Factors](#),” on page 101.

- Select **Limits** as the type for loading the Limit Lines files.
- Select **Corrections** as the type for loading the Transducer Factors files.

NOTE

After loading correction factors for antennas, verify that the reference level unit is set to dB μ V/m

Once the limits have been loaded, **Limit Display** will automatically be set to **On** and the limit line will be displayed on the screen.

Step 10. Press **Display**, **Limits**, **Limit 1**, toggle **Limit Test** to **On**. For more information about using the **Display** function, see the *PSA User’s and Programmer’s reference*.

Step 11. Switch the power of the EUT off and check the display to ensure the noise floor is at least 10 dB below the limit line.

If the noise floor is less than 10 dB below the limit line, toggle **RF Presel Gain** to **On** to improve the noise floor versus limit line.

NOTE

This key is unavailable (grayed-out) when **Use RF Presel** is set to **No**, or **Presel Path** is set to **Bypass**.

Step 12. On the PSA screen, the **PASS/FAIL** indicator will show “PASS LIMIT1” in green color when the peak value of all signals present are below the regulatory limit, or “FAIL LIMIT1” in red color when a signal exceeds the limit being used.

- Step 13.** To analyze signals further, press **Zoom** to split the screen to show two windows:
- The upper window is the previous full-screen window, displaying a full-trace.
 - The lower window displays a portion of the trace.
- Step 14.** Press **Next Window** to toggle to the lower window. The green outlined window is the active window.
- Step 15.** Press **Center Frequency** to set the desired center frequency in the lower window. The value of the center frequency will be automatically coupled according to the data trace captured.
- When you change the center frequency in the lower window, a vertical positioning indicator in the upper window will move accordingly.
- Step 16.** Press **SPAN X Scale, Span** to change the span. The number of the displayed data points in the lower window will be changed accordingly. Around the selected frequency, a minimum of 11 data points and a maximum of 462 data points will be displayed.
- Step 17.** Press **Meas Setup, Meas at Mkr Detector**, you can select or remove the detectors to be used to further analyze signals of interest.
- Toggle **Quasi Peak** to **On** or **Off**.
- Toggle **EMI Average** to **On** or **Off**.
- Step 18.** To adjust the measurement dwell time, press **Meas Setup, Dwell Time** and set the desired time.
- Step 19.** To analyze individual signals, place a marker on the signal of interest and press **Marker Fctn, Measure at Marker** to perform a measurement of that signal.
- For more information about using the Marker functionality, see the *PSA User's and Programmer's Reference*.
- Step 20.** Repeat the measurement procedure until all of the signals greater than or equal to the limit line have been measured and record the measurement results.

File Operation

To access the File menu, press the **File** front-panel key in the **EMC Analyzer** mode.

Saving a Setup file

You can save your current analyzer measurement settings to a Setup file, and load the Setup file the next time you want to repeat the current measurement.

- Step 1.** Press **File, Save, Type** and select **Setup** as the type to be saved.
- Step 2.** Press **Save Now** to save the current measurement settings, including the State, Trace, Limit and Corrections that you set, to a file with a default name *.SET. The next time you turn on the PSA, you can load this Setup file to repeat your test.

NOTE

Some settings will not be saved in the Setup file, for example, RF Preselector IP Address and Source IP Address.

To specify the file name, press **Name** and enter the desired name. To select the directory, use the **Dir Up, Dir Select,** and **Up** and **Down** keys.

Loading a Setup file

- Step 1.** Press **File, Load, Type** and select **Setup** as the type to be loaded.
- Step 2.** Select the file to be loaded.
- Step 3.** Press **Load Now** to load the setup as the current measurement.

Loading a Limit file from the floppy disk

You can load a desired limit line file and turn on the Limit Test.

- Step 1.** Insert the provided floppy disk containing Limit Lines for the most common standards and typical correction factors for a wide variety of measurement transducers.
- Step 2.** Press **File, Load, Type** and select **Limits**.
- Step 3.** Select the desired file on the A: drive.
- Step 4.** Press **Load Now** to load the file into the PSA.

Loading a Corrections file from the floppy disk

You can load a desired Transducer Factor file for antennas and cables you are using.

- Step 1.** Insert the provided floppy disk containing Limit Lines and Transducer Factors.
- Step 2.** Press **File, Load, Type** and select **Corrections**.
- Step 3.** Select the desired file on the A: drive.
- Step 4.** Press **Load Now** to load the file into the PSA.

Interpreting Error Codes

During the execution of your measurement you may encounter problems which generate error codes. The following list of common errors may be helpful.

If **Err** is shown in the annunciator bar, press **System, Show Errors** to see the detailed error information.

- **Connection with Presel could not be established at the IP**

The analyzer cannot communicate with the RF Preselector with the given IP address. This error is reported when communication with the RF Preselector times out.

Verify that the RF Preselector is turned on and the Agilent RF Preselector application is running.

Verify that the LAN connections of the RF Preselector and PSA are correct.

Check the RF Preselector IP address information on the PSA by pressing **Mode Setup, Config EMI Receiver, Show Config**.

Verify compliance with the instrument requirements, see [“Instrument Requirements” on page 21](#), then press **RF Presel Config, Verify RF Presel Connection**. If no error message appears, the connection has been established.

- **RF Presel model is not supported**

The model of the RF Preselector is not supported with the current version of the Option 239 software.

- **Connection with Source could not be established at the IP**

The analyzer cannot communicate with the external signal source with the given IP address. This error is reported when communication with the external signal source times out.

Verify that the source and PSA are turned on.

Verify that the LAN connections of the source and PSA are correct. If your source does not have a LAN port, see [Figure 2-2 on page 24](#) for instructions on how to connect the source, LAN/Gateway, and PSA.

Check the source configuration information by pressing **Mode Setup, Config EMI Receiver, Show Config**.

Verify compliance with instrument requirements, see [“Instrument Requirements” on page 21](#), then press **Source Config, Verify Source Connection**. If no error message appears, the connection has been established.

- **Connection with Source could not be established at the IP/GPIB**

The analyzer cannot communicate with the external signal source with the given IP and GPIB addresses, when the source was connected through a LAN/GPIB gateway. This error is reported when communication with the external signal source times out.

Verify that the source is turned on.

Verify that the LAN/GPIB connections of the source, LAN/Gateway and PSA are correct. See [Figure 2-2 on page 24](#).

Check the source configuration information on the PSA by pressing **Mode Setup, Config EMI Receiver, Show Config**.

Verify compliance with instrument requirements, see [“Instrument Requirements” on page 21](#), then press **Source Config, Verify Source Connection**. If no error message appears, connection has been established.

- **Source model is not supported**

The model of the signal generator is not supported with the current version of the Option 239 software.

Replace the signal generator with a supportable model. See [“Instrument Requirements” on page 21](#) for a list of signal generator models.

- **RF Preselector alignment required, 9 kHz to 1 GHz**

Alignment for the conducted and radiated paths in the RF Preselector needs to be performed.

See [“Aligning the System” on page 27](#) for instructions on how to perform the needed alignment.

- **RF Preselector alignment required, 9 kHz to 30 MHz**

Alignment for the conducted path in the RF Preselector needs to be performed.

If you are making radiated measurements, you can choose to ignore this message.

If you are making conducted measurements, see [“Aligning the System” on page 27](#) for instructions on how to perform the conducted path alignment.

- **RF Preselector alignment required, 30 MHz to 1 GHz**

Alignment for the radiated path in the RF Preselector needs to be performed.

If you are making conducted measurements, you can choose to ignore this message.

If you are making radiated measurements, see [“Aligning the System” on page 27](#) for instructions on how to perform the radiated path alignment.
- **RF Presel input is overloaded**

Increase the RF Preselector attenuation. Press **Mode Setup, Presel Attn** and adjust the attenuation accordingly.
- **RF Preselector alignment terminated by user**

Press the **ESC** key to terminated the RF Preselector alignment.

See [“Aligning the System” on page 27](#) for instructions on how to perform the alignment again before making EMI Receiver measurements.
- **RF Preselector alignment failed, 9 KHz to 30 MHz**

If you are making radiated measurements, you can choose to ignore this message.

If you are making conducted measurements, see [“Aligning the System” on page 27](#) for instructions on how to perform the conducted path alignment.
- **RF Preselector alignment failed, 30 MHz to 1 GHz**

If you are making conducted measurements, you can choose to ignore this message.

If you are making radiated measurements, see [“Aligning the System” on page 27](#) for instructions on how to perform the radiated path alignment.
- **Freq crossing of conducted and radiated bands is not supported**

When Preset path is set to Filter, the instrument sweep cannot cross over both the conducted and radiated bands.

Either select a band by pressing **Mode Setup, EMI Presets** or toggle the preselector path to **Bypass** by pressing **Input/Output, Presel Path**.

- **RF Preselector changed, new alignment required**

The RF Preselector in the system has been changed. A new alignment for the RF Preselector is needed.

See [“Aligning the System” on page 27](#) for instructions on how to perform the needed alignment.

- **Cal Source Signal missing, check all the connections**

The analyzer could not detect an input signal from the calibration source.

Verify that the source is turned on.

Verify that the cable connections are correct:

- Source RF OUT to the RF Preselector SRC IN
- RF Preselector RF OUT to the PSA RF INPUT.

- **Not available when zoomed graph selected**

Some key functions are not supported when the lower window of the zoomed graph is selected.

3 Front-Panel Key and SCPI Command Reference

This chapter provides detailed descriptions of the front-panel keys and the associated SCPI commands and screens used to set up and make EMI Receiver measurements.

3.1 Instrument Front Panel Highlights

The most commonly used function keys on the PSA front panel are located as shown in the illustrations below. The operation of the keys is briefly explained on the following page. Refer to your PSA Series User's Guide for complete details on all keys.

Figure 3-1 Selected PSA Series Front Panel Feature Locations

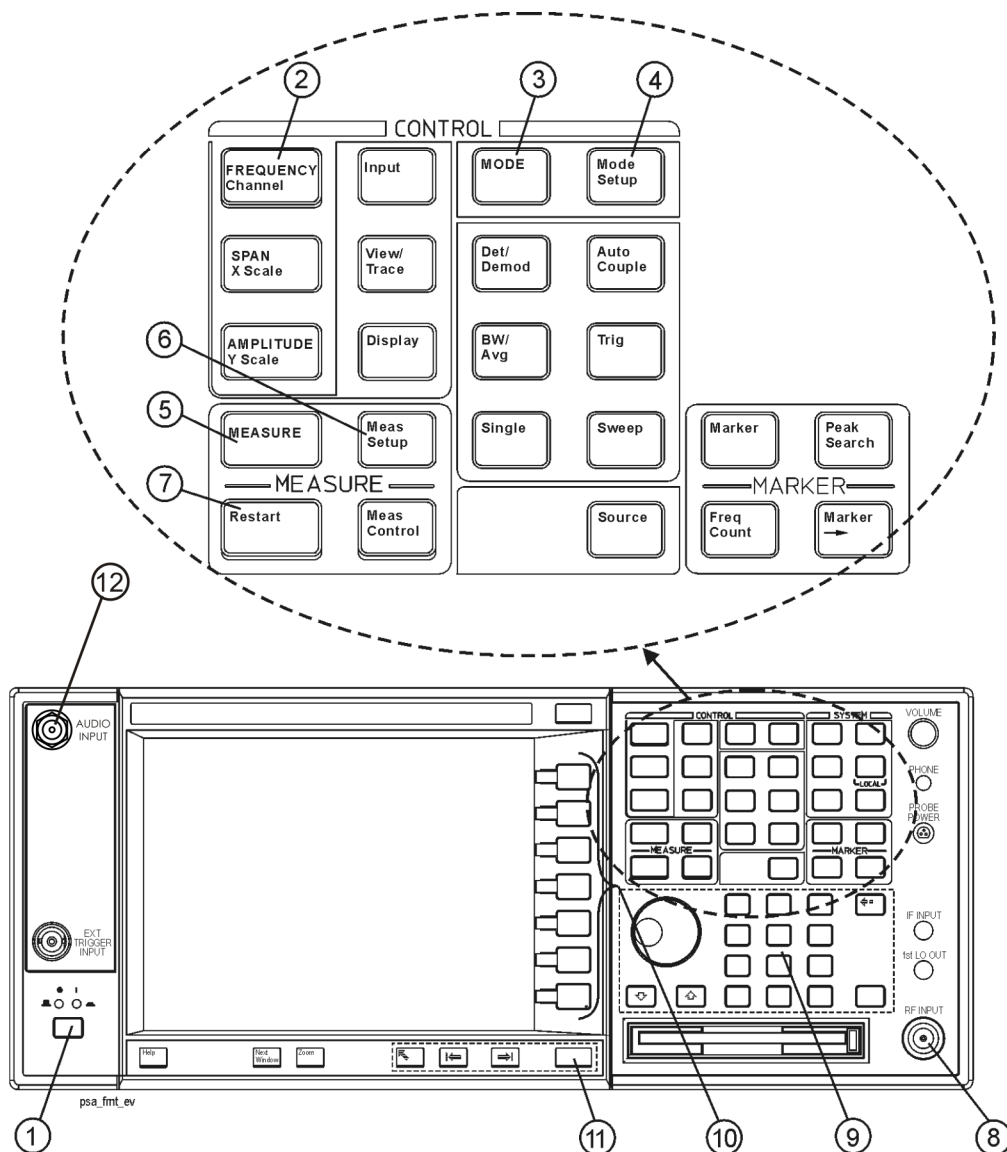

3.1.1 Selected and PSA Front-Panel Features

1. The **On/Off** switch toggles the AC Line power between On and Standby. A green LED will light

- when the instrument is On. When energized in the standby mode, a yellow LED is lit above the switch.
2. **FREQUENCY Channel** accesses a key menu to set the analyzer center frequency in units of Hz, kHz, MHz, or GHz, or by channel number. These parameters apply to all measurements in the current mode.
 3. **MODE** accesses a key menu to select one of the measurement personalities installed in the instrument. Each mode is independent from all other modes.
 4. **Mode Setup** accesses a key menu that sets parameters specific to the current mode and can affect all measurements within that mode.
 5. **MEASURE** accesses a display key menu to initiate one of the various measurements that are specific to the current mode.
 6. **Meas Setup** accesses the menus of test parameters that are specific to the current measurement.
 7. **Restart** causes a measurement to start again from the initial process according to the current measurement setup parameters.
 8. **RF INPUT** port: Type N connector for the E4443A, E4445A, and E4440A PSAs. It is a 2.4 mm connector on the E4446A, E4447A and E4448A PSAs and a 3.5 mm connector on all PSAs with Opt BAB. The maximum input power level is shown next to the port.
 9. The **Data Entry** keypad is used to enter numeric values. Keypad entries are displayed in the active function area of the screen and become valid for the current measurement upon pressing the **Enter** key or selecting a unit of measurement, depending on the parameter.
 10. The Display Menu keys allow you either to activate a feature or to access a more detailed sub-menu. An arrow on the right side of a softkey label indicates that the key has a further selection menu. The active menu key is highlighted, however, grayed-out keys are currently unavailable for use or only show information. If a menu has multiple pages, successive pages are accessed by pressing the **More** key located at the bottom of the menu.
 11. **Return** allows you to exit the current menu and display the previous menu. If you are on the first page of a multi-page menu (a menu with **(1 of 3)** for example), the **Return** key will exit from that menu. When you activate another measurement, the return list is cleared. The **Return** key will not return you to a previously activated mode, nor will it alter any values you have entered in previous menus.
 12. BNC Audio Input (PSA Option 233 Measuring Receiver only) Provides a 100 kOhm input for audio measurements. Frequency range is 20 Hz to 250 kHz. The safe input level is 7 Vrms or 20 V DC.

3.2 Front-Panel Keys

NOTE Only front-panel keys affected by selecting the EMC Analyzer mode are described here. For a complete description of all front-panel keys, see the *PSA Series User's and Programmer's Guide*.

3.2.1 Center Frequency, Span for lower window

Allows you to access the center frequency setup menu.

3.2.1.1 Center Frequency

Allows you to set the desired frequency for the lower window.

Mode:	EMC Analyzer
Key Path:	FREQUENCY/Channel
Remote Command:	[:SENSE] :EMI :FREQuency [:CENTer] [:SENSe] :EMI :FREQuency [:CENTer] ?
Preset:	The center frequency of the upper window
State Saved:	Saved in instrument state.
Min:	Dependent on the start freq of upper window ^a
Max:	Dependent on the stop freq of upper window ^b
Dependencies/Couplings:	When the start frequency, stop frequency, center or span of the upper window changes, it results in a new frequency boundary (start Freq, stop Freq) in the upper window. If the frequency range of the lower window exceeds the new boundary of the upper window, the center freq of the lower window is reset to the center Freq of the upper window, span is also reset to minimum of the 462 pixels and boundary limitation.
Example:	:EMI:FREQ 10000.0 :EMI:FREQ?

$$a. \text{Min} = \text{Start Freq}_{\text{upper window}} + \text{Span}_{\text{upper window}} / (\text{SweepPoint}_{\text{upper window}} - 1) * 5$$

$$b. \text{Max} = \text{Stop Freq}_{\text{upper window}} - \text{Span}_{\text{upper window}} / (\text{SweepPoint}_{\text{upper window}} - 1) * 5$$

3.2.1.2 Span

Allows you to set the span.

Mode:	EMC Analyzer
Key Path:	SPAN/X Scale, Span
Remote Command:	[:SENSe] :EMI :FREQuency :SPAN [:SENSe] :EMI :FREQuency :SPAN?
Preset:	VFreq: freq of vertical marker USpan: span of upper window USweepPoint: sweep point of upper window RightDistance(Hz): vertical marker to right boundary in upper window. LeftDistance(Hz): vertical marker to left boundary in upper window. Minimal Distance(Hz) = min(RightDistance, LeftDistance) LSpan: span of lower window LSpan = min(USpan / USweepPoint * 231, Minimal Distance)*2; max value of sweep points in lower window is 462.
State Saved:	Saved in instrument state.
Min:	USpan/USweepPoint * 10
Max:	min Of (USpan/USweepPoint*461, Minimal Distance)
Dependencies/Couplings:	When the start frequency, stop frequency, center or span of the upper window changes, it results in a new frequency boundary (start Freq, stop Freq) in the upper window. If the frequency range of the lower window exceeds the new boundary of the upper window, the center freq of the lower window is reset to the center Freq of the upper window, span is also reset to minimum of the 462 pixels and boundary limitation.
Example:	:EMI:FREQ:SPAN 10000.0 :EMI:FREQ:SPAN?

3.2.2 File

The setup file is a complete set of instrument parameters including traces, states, limits, and corrections.

3.2.2.1 Save Setup

Saves a setup file to the floppy (A:) or internal (C:) drive.

Mode:	EMC Analyzer
Key Path:	File, Save
Remote Command:	:MMEMory:STORe:SETup <'file_name'>
Dependencies/Couplings:	None.
Example:	:MMEM:STOR:SET 'C:\SETUP001.SET'

3.2.2.2 Load Setup

Load the setup information from a setup file.

Mode:	EMC Analyzer
Key Path:	File, Load
Remote Command:	:MMEMory:LOAD:SETup <'file_name'>
Dependencies/Couplings:	None.
Example:	:MMEM:LOAD:SET 'C:\SETUP001.SET'

3.2.3 Input/ Output

PSA Option 239 adds new functions to the existing PSA Input/Output menu.

3.2.3.1 RF Pesel Path

Allows you to select the RF path of the RF Preselector.

Mode:	EMC Analyzer
Key Path:	Input/Output, Presel Path
Remote Command:	:INPut:PRESelector[:EXTErnal]:PATH FILTEr BYPass :INPut:PRESelector[:EXTErnal]:PATH?
Preset:	Bypass
State Saved:	Saved in instrument state.
Dependencies/Couplings:	The PSA sends [:SENSE]:FEED:PATH BYPass FILTEr to the RF Preselector to set its path
Example:	:INP:PRES:PATH FILT :INP:PRES:PATH?

3.2.3.2 RF Pesel Input

Allows you to select the RF Preselector input.

Mode:	EMC Analyzer
Key Path:	Input/Output, Presel Input
Remote Command:	:INPut:PRESelector[:EXTErnal] RF SOURce :INPut:PRESelector[:EXTErnal]?
Preset:	RF
State Saved:	Saved in instrument state.
Dependencies/Couplings:	The PSA sends [:SENSE]:FEED RF SOURce to the RF Preselector to set the input path.
Example:	:INP:PRES RF :INP:PRES?

3.2.4 Marker Function

Displays the marker function menu for the Emissions measurement when the **Marker Fctn** key has been pressed. A new key function, Measure at Marker, is added to the menu.

3.2.4.1 Measure at Marker

Allows you to activate the Measure at Marker function.

Mode: EMC Analyzer

Key Path: **Marker Fctn, Measure at Marker**

Remote Command: :MEASure:EMI:MARKer
:MEASure:EMI:MARKer [1] | 2 | 3 | 4?

Remote Command Notes: The size of the returned results array is fixed at 4.

- EMI peak value
- EMI QP value
- EMI Average value
- Frequency of Marker

Restriction and Notes: This query command returns comma separated values for the Peak Detector, EMI Average Detector, Quasi Peak Detector and the frequency value of the measured signal. If the Detector is off or if a measurement has not yet been made, -999.0 will be returned.

:MEAS:EMI:MARK makes a Measure at Marker measurement at the active marker frequency.

It's highly recommended to use the :MEAS:EMI:MARK;*OPC? commands. The *OPC? command returns a one when the measurement is done.

:MEAS:EMI:MARK2? returns the previously made measurement if it was made with marker 2 active.

Example: :MEAS:EMI:MARK;*OPC?
:MEAS:EMI:MARK?

3.2.5 Meas Control

These functions allow you to pause and resume the currently selected measurement and to select between continuous or single measurements.

3.2.5.1 Restart

Press this key to repeat the current measurement from the beginning, while retaining the current measurement settings. This is equivalent to the **Restart** front-panel key.

Key Path:	Meas Control
Remote Command:	:INITiate:REStart
Remote Command Notes:	This command is equivalent to sending an :ABORt command followed by an :INITiate[:IMMediate] command.
Example:	:INIT:REST

3.2.5.2 Measure

Allows you to toggle the measurement state between **Single** and **Cont** (continuous).

This key has a different function than the **MEASURE** front panel key. When set to **Single**, the measurement will continue until it has reached the specified number of averages set by the average counter. When set to **Cont**, the measurement will run continuously and execute averaging according to the current average mode, either repeat or exponential.

Key Path	Meas Control
Factory Preset	Cont
State Saved	Saved in instrument state.
Remote Command	:INITiate:CONTinuous OFF ON
Remote Command Notes	<p>When the key is set to ON, at the completion of each trigger cycle, the trigger system immediately initiates another trigger cycle.</p> <p>When the key is set to OFF, the trigger system remains in an “idle” state until CONTinuous is set to ON or an :INITiate[:IMMediate] command is received. On receiving the :INITiate[:IMMediate] command, it will go through a single trigger cycle, and then return to the “idle” state.</p> <p>The query INIT:CONT? returns 1 or 0. 1 is returned when the instrument is continuous triggering. 0 is returned when it is single triggering.</p>
Example	:INIT:CONT OFF

3.2.5.3 Pause/Resume

Press this key to pause the current measurement. Once toggled, the label of the **Pause** key changes to read Resume. The **Resume** key, once pressed, continues the active measurement from the point at which it was paused.

Key Path:	Meas Control
Remote Command:	:INITiate:PAUSE :INITiate:RESume
Example:	:INIT:PAUS

3.2.6 Mode

Accesses a menu that displays the installed personality modes. The minimum set of available modes is:

- **Spectrum Analysis**
- **EMC Analyzer**

This menu will have additional entries if other personalities have been installed, for example GSM/EDGE Option 202 or cdmaOne Option BAC.

For information related to the operation of the Spectrum Analysis mode refer to the *PSA User's and Programmer's Guide*.

For information related to the operation of the Basic mode refer to the *PSA Basic Mode Guide*.

3.2.6.1 Instrument Selection by Name

Allows you to change from the current mode to the EMC Analyzer mode. This has the same affect as pressing the **EMC Analyzer** key.

Key Path:	MODE, EMC Analyzer
Remote Command:	:INSTrument [:SElect] SA EMC :INSTrument [:SElect] ?
Preset:	SA
Example:	INST EMC INST?

3.2.6.2 Instrument Selection by Number (Remote command only)

This remote command allows you to change from the current mode to EMC Analyzer mode (Option 239). This has the same effect as pressing the **EMC Analyzer** key.

Remote Command: :INSTrument:NSElect 239
 :INSTrument:NSElect?

Example: INST:NSEL 239
 INST:NSEL?

3.2.7 Mode Setup

Accesses all menus that enable you to change parameters for the available measurements.

3.2.7.1 EMI Presets

Allows you to select the desired EMI CISPR Band

Mode: EMC Analyzer

Key Path: **Mode Setup, EMI Presets**

Remote Command: [:SENSe]:FREQuency:PRESelector[:EXTernal]:PBANd
 A|B|C|D|CD|E|UPPer
 [:SENSe]:FREQuency:PRESelector[:EXTernal]:PBANd?

Preset: Upper

State Saved: Saved in instrument state.

Dependencies/Couplings: Selecting these bands will automatically set up RBW, Start/ Stop Freq, Trace Points, EMI Peak Detector, units in dBμV and so on for CISPR measurement. See [Table 2-4, “The default values when the EMI Presets key is pressed for a full-compliance measurement,” on page 34](#)

Example: :FREQ:PRES:PBAN A
 :FREQ:PRES:PBAN?

3.2.7.2 Use RF Preselector

Selects whether the RF Preselector is used or not.

Mode:	EMC Analyzer
Key Path:	Mode Setup, Use RF Presel
Remote Command:	<code>[:SENSe] :POWer [:RF] :PRESelector [:EXTernal] :USE YES NO</code> <code>[:SENSe] :POWer [:RF] :PRESelector [:EXTernal] :USE?</code>
State Saved:	Saved in instrument state.
Range:	Yes No
Example:	<code>:POW:PRES:USE NO</code> <code>:POW:PRES:USE?</code>

3.2.7.3 RF Presel Attenuator

Changes the RF Preselector attenuator setting.

Mode:	EMC Analyzer
Key Path:	Mode Setup, RF Presel Att
Remote Command:	<code>[:SENSe] :POWer [:RF] :PRESelector [:EXTernal] :ATTenuation <numeric value></code> <code>[:SENSe] :POWer [:RF] :PRESelector [:EXTernal] :ATTenuation?</code>
Preset:	10
State Saved:	Saved in instrument state.
Min:	0
Max:	57.5 dB
Dependencies/Couplings:	The PSA sends <code>[:SENSe] :POWer [:RF] :ATTenuation <numeric></code> to the RF Preselector when you change this setting. The parameter is disabled when <code>usePresel = No</code> or <code>usePresel = Yes</code> , in bypass mode. If Presel Atten is set to less than 10 dB, it will be coupled to 10.0 dB, unless it is 0 dB, it is still set to 0 dB.
Example:	<code>:POW:PRES:ATT 10</code> <code>:POW:PRES:ATT?</code>

3.2.7.4 RF Presel Gain

Turns the RF Preselector Gain on and off.

Mode:	EMC Analyzer
Key Path:	Mode Setup, RF Presel Gain
Remote Command:	[:SENSE] :POWER [:RF] :PRESelector [:EXTernal] :GAIN [:STATe] ON OFF 0 1 [:SENSE] :POWER [:RF] :PRESelector [:EXTernal] :GAIN [:STATe] ?
Preset:	Off
State Saved:	Saved in instrument state.
Dependencies/Couplings:	The PSA sends [:SENSe] :POWer [:RF] :GAIN [:STATe] ON OFF 0 1 to the RF Preselector when you change the setting. The parameter is disabled if usePresel = No or usePresel = Yes, in bypass mode
Example:	POW:PRES:GAIN 1 POW:PRES:GAIN?

3.2.7.5 EMI Receiver IO Configuration

This menu allows you to configure the IO information of the external RF Preselector and source.

3.2.7.5.1 RF Preselector Configuration

Sets the IO configuration parameters of the RF Preselector.

3.2.7.5.1.1 Preselector IP Address

Sets the IP Address of the RF Preselector to be controlled by the PSA.

Mode:	EMC Analyzer
Key Path:	Mode Setup, Config EMI Receiver, RF Presel Config
Remote Command:	:SYSTem:COMMunicate:LAN:PRESelector [:EXTernal] :IP <string> :SYSTem:COMMunicate:LAN:PRESelector [:EXTernal] :IP?
State Saved:	Persistent, survives a preset and a power cycle but is not saved in the instrument state
Example:	:SYST:COMM:LAN:PRES:IP 255.255.0.0 :SYST:COMM:LAN:PRES:IP?

3.2.7.5.1.2 Pre-selector Time Out

Sets the time out value when testing the PSA to the RF Preselector connection.

Mode:	EMC Analyzer
Key Path:	Mode Setup, Config EMI Receiver, RF Presel Config, Time Out
Remote Command:	:SYSTem:COMMunicate:PRESelector:TCONnect:TOUT <time> :SYSTem:COMMunicate:PRESelector:TCONnect:TOUT?
Min:	1.0s
Max:	120.0s
Example:	SYST:COMM:PRES:TCON:TOUT 10 SYST:COMM:PRES:TCON:TOUT?

3.2.7.5.1.3 Verify RF Preselector Connection

Tests the Connection from the PSA to the RF Preselector.

Mode:	EMC Analyzer
Key Path:	Mode Setup, Config EMI Receiver, RF Presel Config, Verify RF Presel Connection
Remote Command:	:SYSTem:COMMunicate:PRESelector:TCONnect :SYSTem:COMMunicate:PRESelector:TCONnect?
Remote Command Notes:	The query command returns a zero if the connection has been verified and returns a one if not.
Example:	SYST:COMM:PRES:TCON?

3.2.7.5.1.4 Preselector IDN String (Remote Command Only)

Allows a query of the “*IDN?” string of the external RF Preselector directly from the PSA.

Mode:	EMC Analyzer
Remote Command:	:SYSTem:COMMunicate:PRESelector:IDN?
Dependencies/Couplings:	The PSA sends *IDN to the RF Preselector to query its information. The parameter is disabled if a connection has not been established at the specified IP address of the RF Preselector.
Example:	:SYST:COMM:PRES:IDN?

3.2.7.5.2 Source Config

Sets the IO configuration parameter of the source.

3.2.7.5.2.1 Source Model Number

Selects the model number of the source that the PSA will connect to.

Mode: EMC Analyzer

Key Path: **Mode Setup, Config EMI Receiver, Source Config, Model Number**

Remote Command: :SYSTem:COMMunicate:ESource:TYPE
 B8648|MXG|N5181A|N5182A|ESG|E4438C|PSG|E8257D
 :SYSTem:COMMunicate:ESource:TYPE?

Note:

1. :SYSTem:COMMunicate:ESource:TYPE MXG is equal to :SYSTem:COMMunicate:ESource:TYPE N5181A.
2. After sending :SYSTem:COMMunicate:ESource:TYPE N5181A, sending :SYSTem:COMMunicate:ESource:TYPE? to query, may return MXG instead of N5181A.
3. :SYSTem:COMMunicate:ESource:TYPE ESG is equal to :SYSTem:COMMunicate:ESource:TYPE E4438C.
4. After sending :SYSTem:COMMunicate:ESource:TYPE E4438C, sending :SYSTem:COMMunicate:ESource:TYPE? to query, may return ESG instead of E4438C.
5. :SYSTem:COMMunicate:ESource:TYPE PSG is equal to :SYSTem:COMMunicate:ESource:TYPE E8257D.
6. After sending :SYSTem:COMMunicate:ESource:TYPE E8257D, sending :SYSTem:COMMunicate:ESource:TYPE? to query, may return PSG instead of E8257D.

Preset B8648

State Saved: Saved in instrument state.

Dependencies/Couplings: When the 8648B is selected, the connection mode is set to LAN/GPIB Gateway and conn Mode will be unavailable (greyed out).
 When the connection mode is set to LAN, the GPIB Address and Logic Unit will be unavailable (greyed out).

Example: :SYST:COMM:ESO:TYPE B8648
 :SYST:COMM:ESO:TYPE?

Front-Panel Keys

3.2.7.5.2.2 Source Connection Mode

Sets how the PSA is connected with the source.

Mode:	EMC Analyzer
Key Path:	Mode Setup, Config EMI Receiver, Source Config, Conn Mode
Remote Command:	:SYSTem:COMMunicate:ESource:CONNecTion LAN LG :SYSTem:COMMunicate:ESource:CONNecTion?
Preset:	LAN
State Saved:	Saved in instrument state.
Example:	:SYST:COMM:ESO:CONN LAN :SYST:COMM:ESO:CONN?

3.2.7.5.2.3 Source IP Address

Sets the IP Address of the source to be controlled by the RF Preselector during system alignment.

Mode:	EMC Analyzer
Key Path:	Mode Setup, Config EMI Receiver, Source Config, IP Address
Remote Command:	:SYSTem:COMMunicate:LAN:ESource[:EXTernal]:IP <string> :SYSTem:COMMunicate:LAN:ESource[:EXTernal]:IP?
State Saved:	Persistent, survives a preset and a power cycle but is not saved in the instrument state.
Example:	:SYST:COMM:LAN:ESO:IP 255.255.0.1 :SYST:COMM:LAN:ESO:IP?

3.2.7.5.2.4 Source GPIB Address

Sets the GPIB address of the source.

Mode:	EMC Analyzer
Key Path:	Mode Setup, Config EMI Receiver, Source Config, GPIB Address
Remote Command:	:SYSTem:COMMunicate:GPIB:ESource[:EXTernal]:ADDRess <integer> :SYSTem:COMMunicate:GPIB:ESource[:EXTernal]:ADDRess?
State Saved:	Persistent, survives a preset and a power cycle but is not saved in the instrument state.
Example:	:SYST:COMM:GPIB:ESO:ADDR 19 :SYST:COMM:GPIB:ESO:ADDR?

3.2.7.5.2.5 Source Logical Unit

Sets the Logical Unit of the source.

Mode:	EMC Analyzer
Key Path:	Mode Setup, Config EMI Receiver, Source Config, Logic Unit
Remote Command:	:SYSTem:COMMunicate:GPIB:ESource[:EXTernal]:LUNit <integer> :SYSTem:COMMunicate:GPIB:ESource[:EXTernal]:LUNit?
State Saved:	Persistent, survives a preset and a power cycle but is not saved in the instrument state.
Dependencies/Couplings:	Set according to the coupling in the Model number.
Preset:	7
Min:	0
Max:	99
Example:	:SYST:COMM:GPIB:ESO:LUNit 7 :SYST:COMM:GPIB:ESO:LUNit?

3.2.7.5.2.6 Source Time Out

Sets the time out value when testing the PSA to the source connection.

Mode:	EMC Analyzer
Key Path:	Mode Setup, Config EMI Receiver, Source Config, Time Out
Remote Command:	:SYSTem:COMMunicate:ESource:TCONnect:TOUT <time> :SYSTem:COMMunicate:ESource:TCONnect:TOUT?
Min:	1.0s
Max:	120.0s
Example:	SYST:COMM:ESO:TCON:TOUT 10 SYST:COMM:ESO:TCON:TOUT?

Front-Panel Keys

3.2.7.5.2.7 Verify Source Connection

Tests the connection from the PSA to the source.

Mode: EMC Analyzer

Key Path: **Mode Setup, Config EMI Receiver, Source Config, Verify Source Connection**

Remote Command: :SYSTem:COMMunicate:ESource:TCONnect
:SYSTem:COMMunicate:ESource:TCONnect?

Remote Command Notes: The query command returns a zero if the connection has been verified and returns a one if not.

Example: SYST:COMM:ESO:TCON?

3.2.7.5.2.8 Source IDN String (Remote Command Only)

Allows a query of the “*IDN?” string of the external source directly from the PSA.

Mode: EMC Analyzer

Remote Command: :SYSTem:COMMunicate:ESoure:IDN?

Example: :SYST:COMM:ESO:IDN?

3.2.7.5.3 Show Config

Displays a form showing the current configuration information of the RF Preselector and the source at the specified IP Addresses.

Mode: EMC Analyzer

Key Path: **Mode Setup, Config EMI Receiver, Show Config**

Dependencies/Couplings: If the source or the RF Preselector cannot be connected successfully, the corresponding items will be blank.

Remote Command Notes: Front panel access only.

3.2.7.5.4 Hardware Connection Instruction

Displays a screen showing how to set up the connections of the whole EMI receiver system in preparation for alignment.

Mode: EMC Analyzer

Key Path: **Mode Setup, Config EMI Receive, HW Connection Instruction**

Remote Command Notes: Front panel access only.

3.2.7.6 Align EMI Preselector

Allows you to initiate the alignment of the RF Preselector. You can choose to align the conducted (9 kHz to 30 MHz) or the radiated (30 MHz to 1 GHz) paths separately, or both at one time.

3.2.7.6.1 Align 9 kHz to 30 MHz

Aligns the conducted path (9 kHz to 30 MHz) of the RF Preselector.

Mode: EMC Analyzer

Key Path: **Mode Setup, Align RF Presel, Align 9 kHz to 30 MHz**

Remote Command: :CALibration:PRESelector:EXTernal:AB
 :CALibration:PRESelector:EXTernal:AB[:STATe]?

Remote Command Notes: The query command returns a zero if the alignment is successful and returns a one if any part of the alignment fails.

It is highly recommended to use the :CAL:PRES:EXT:AB;*OPC? commands. The *OPC? command returns a one when the alignment is done.

Example: :CAL:PRES:EXT:AB;*OPC?
 :CAL:PRES:EXT:AB?

3.2.7.6.2 Align 30 MHz to 1 GHz

Aligns the radiated path (30 MHz to 1 GHz) of the RF Preselector.

Mode: EMC Analyzer

Key Path: **Mode Setup, Align RF Presel, Align 30 MHz to 1 GHz**

Remote Command: :CALibration:PRESelector:EXTernal:CD
 :CALibration:PRESelector:EXTernal:CD[:STATe]?

Remote Command Notes: The query command returns a zero if the alignment is successful and returns a one if any part of the alignment fails.

It is highly recommended to use the :CAL:PRES:EXT:CD;*OPC? commands. The *OPC? command returns a one when the alignment is done.

Example: :CAL:PRES:EXT:CD;*OPC?
 :CAL:PRES:EXT:CD?

3.2.7.6.3 Align 9 kHz to 1 GHz

Aligns both the conducted (9 kHz to 30 MHz) and the radiated (30 MHz to 1 GHz) paths of the RF Preselector.

Mode: EMC Analyzer

Key Path: **Mode Setup, Align RF Presel, Align 9 kHz to 1 GHz**

Remote Command: :CALibration:PRESelector:EXTErnal:ALL
:CALibration:PRESelector:EXTErnal:ALL[:STATe]?

Remote Command Notes: The query command returns a zero if the alignment is successful and returns a one if any part of the alignment fails.

It is highly recommended to use the :CAL:PRESEL:EXT:ALL;*OPC? commands. The *OPC? command returns a one when the alignment is done.

Example: :CAL:PRESEL:EXT:ALL;*OPC?
:CAL:PRESEL:EXT:ALL?

3.2.7.6.4 Restore Pre-selector Align Default

Loads the default calibration values to the RF Preselector.

Mode: EMC Analyzer

Key Path: **Mode Setup, Align RF Presel, Restore Presel Align Default**

Remote Command: :CALibration:PRESelector:EXTErnal:DEFault

Dependencies/Couplings: The PSA sends :CALibration:DATA:DEFault to Preselector.

It is highly recommended to use the :CAL:PRESEL:EXT:DEF;*OPC? commands. The *OPC? command returns a one when the alignment is done.

Example: :CAL:PRESEL:EXT:DEF;*OPC?

3.2.8 System

The PSA Option 239 adds new commands to the existing PSA system function and changes some existing PSA commands to work with the RF Preselector as an EMI Receiver system.

3.2.8.1 Show Error

The errors generated during the EMI Receiver system alignment and measurement are shown in the error History. Clear Error Queue will clear the PSA and the RF Preselector Errors queue if errors exist.

3.3 Measure

Accesses the Measure menus.

3.3.1 Command Interactions: MEASure, CONFigure, FETCh, INITiate and READ

Figure 1 Measurement Group of Commands

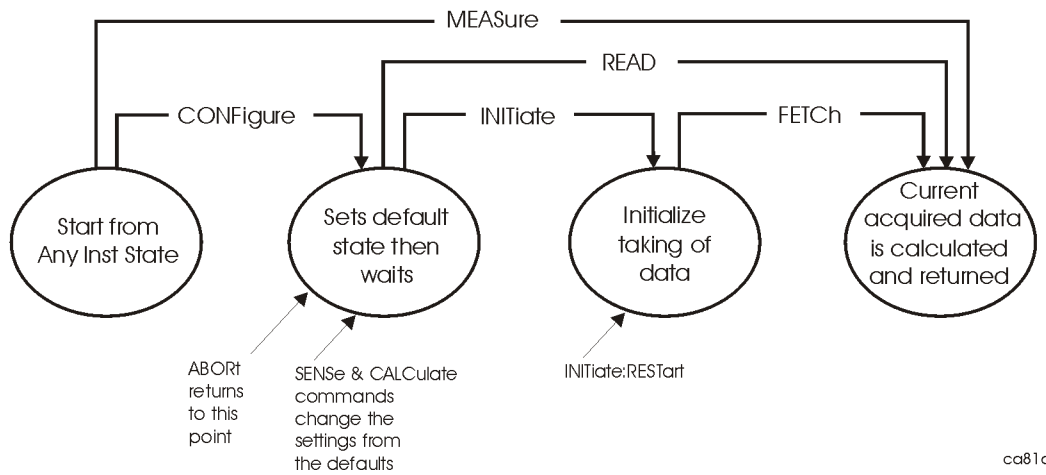

Measure Commands:

:MEASure:<measurement> [n] ?

This is a fast single-command way to make a measurement using the factory default instrument settings. These are the settings and units that conform to the Mode Setup settings (e.g. radio standard) that you have currently selected.

- Stops the current measurement (if any) and sets up the instrument for the specified measurement using the factory defaults
- Initiates the data acquisition for the measurement
- Blocks other SCPI communication, waiting until the measurement is complete before returning results.
- After the data is valid it returns the scalar results, or the trace data, for the specified measurement. The type of data returned may be defined by an [n] value that is sent with the command.

The scalar measurement results will be returned if the optional [n] value is not included, or is set to 1. If the [n] value is set to a value other than 1, the selected trace data results will be returned. See each command for details of what types of scalar results or trace data results are available.

ASCII is the default format for the data output. The binary data formats should be used for handling large blocks of data since they are smaller and faster than the ASCII format. Refer to the FORMat:DATA command for more information.

If you need to change some of the measurement parameters from the factory default settings you can set up the measurement with the CONFigure command. Use the commands in the SENSE:<measurement> and CALCulate:<measurement> subsystems to change the settings. Then you can use the READ? command to initiate the measurement and query the results. See [Figure 1](#).

If you need to repeatedly make a given measurement with settings other than the factory defaults, you can use the commands in the SENSE:<measurement> and CALCulate:<measurement> subsystems to set up the measurement. Then use the READ? command to initiate the measurement and query results.

Measurement settings persist if you initiate a different measurement and then return to a previous one. Use READ:<measurement>? if you want to use those persistent settings. If you want to go back to the default settings, use MEASure:<measurement>?.

Configure Commands:

:CONFigure:<measurement>

This command stops the current measurement (if any) and sets up the instrument for the specified measurement using the factory default instrument settings. It sets the instrument to single measurement mode but should not initiate the taking of measurement data unless INIT:CONTinuous is ON. After you change any measurement settings, the READ command can be used to initiate a measurement without changing the settings back to their defaults.

The CONFigure? query returns the current measurement name.

Fetch Commands:

:FETCh:<measurement> [n] ?

This command puts selected data from the most recent measurement into the output buffer. Use FETCh if you have already made a good measurement and you want to return several types of data (different [n] values, e.g. both scalars and trace data) from a single measurement. FETCh saves you the time of re-making the measurement. You can only FETCh results from the measurement that is currently active, it will not change to a different measurement.

If you need to get new measurement data, use the READ command, which is equivalent to an INITiate followed by a FETCh.

The scalar measurement results will be returned if the optional [n] value is not included, or is set to 1. If the [n] value is set to a value other than 1, the selected trace data results will be returned. See each command for details of what types of scalar results or trace data results are available. The binary data formats should be used for handling large blocks of data since they are smaller and transfer faster than the ASCII format. (FORMat:DATA)

FETCh may be used to return results other than those specified with the original READ or MEASure command that you sent.

INITiate Commands:

:INITiate:<measurement>

This command is not available for measurements in all the instrument modes:

- Initiates a trigger cycle for the specified measurement, but does not output any data. You must then use the FETCh<meas> command to return data. If a measurement other than the current one is specified, the instrument will switch to that measurement and then initiate it.
For example, suppose you have previously initiated the ACP measurement, but now you are running the channel power measurement. If you send INIT:ACP? it will change from channel power to ACP and will initiate an ACP measurement.
- Does not change any of the measurement settings. For example, if you have previously started the ACP measurement and you send INIT:ACP? it will initiate a new ACP measurement using the same instrument settings as the last time ACP was run.
- If your selected measurement is currently active (in the idle state) it triggers the measurement, assuming the trigger conditions are met. Then it completes one trigger cycle. Depending upon the measurement and the number of averages, there may be multiple data acquisitions, with multiple trigger events, for one full trigger cycle. It also holds off additional commands on GPIB until the acquisition is complete.

READ Commands:

:READ:<measurement> [n] ?

- Does not preset the measurement to the factory default settings. For example, if you have previously initiated the ACP measurement and you send READ:ACP? it will initiate a new measurement using the same instrument settings.
- Initiates the measurement and puts valid data into the output buffer. If a measurement other than the current one is specified, the instrument will switch to that measurement before it initiates the measurement and returns results.

For example, suppose you have previously initiated the ACP measurement, but now you are running the channel power measurement. Then you send READ:ACP? It will change from channel power back to ACP and, using the previous ACP settings, will initiate the measurement and return results.

- Blocks other SCPI communication, waiting until the measurement is complete before returning the results

If the optional [n] value is not included, or is set to 1, the scalar measurement results will be returned. If the [n] value is set to a value other than 1, the selected trace data results will be returned. See each command for details of what types of scalar results or trace data results are available. The binary data formats should be used when handling large blocks of data since they are smaller and faster than the ASCII format. (FORMat:DATA)

3.3.2 Emissions

Allows you to switch to the Emissions measurement.

Mode: EMC Analyzer

Key Path: **MEASURE**

Remote Command: See [“Remote SCPI Result - SCPI Only Commands”](#) on page 74

Table 3-1 Remote SCPI Result - SCPI Only Commands

Command	Index: n <Mnemonic>	Results Returned
:CONFigure:EMI	N/A	Not Applicable
:INITiate:EMI	N/A	Not Applicable
:FETCh:EMI [n] ?	0	Swept trace
:MEASure:EMI [n] ?	0	Swept trace
:READ:EMI [n] ?	0	Swept trace

3.4 Measurement Key

The Emissions measurement is currently the only available measurement in the EMC Analyzer Mode.

3.4.1 Emissions Measurement

When you press the **Emissions** key you get a full-trace window as a default display. When you press the front-panel **Zoom** key, you get a split screen with the following two windows:

- Full-Trace window (upper) - same as the default display.
- User-Defined window (lower) - a user-selectable number of points around a vertical marker line is displayed.

3.4.1.1 Meas Setup

Displays the measurement setup menu for the Emissions Measurement.

3.4.1.1.1 Quasi Peak Detector

Allows you to turn on or off the Quasi Peak detector for the Measure at Marker function.

Key Path:	Meas Setup, Meas at Mkr Detector, Quasi Peak
Mode:	EMC Analyzer
Remote Command:	<code>[:SENSe] :EMI :MEASure :DETEctor :QPEak [:STATe] OFF ON 0 1 </code>
Preset:	On
State Saved:	Saved in instrument state
Example:	<code>:EMI:MEAS:DET:QPE ON</code>

3.4.1.1.2 EMI Average Detector

Allows you to turn on or off the EMI Average Detector for the Measure at Marker function.

Key Path:	Meas Setup, Meas at Mkr Detector, EMI Average
Mode:	EMC Analyzer
Remote Command:	<code>[:SENSe] :EMI :MEASure :DETEctor :AVERage [:STATe] OFF ON 0 1 </code>
Preset:	On
State Saved:	Saved in instrument state
Example:	<code>:EMI:MEAS:DET:AVER ON</code>

3.4.1.1.3 Dwell Time

Allows you to setup the detector Dwell Time for the Measure at Marker function.

Mode:	EMC Analyzer
Key Path:	Meas Setup, Dwell Time
Remote Command:	<code>[:SENSe] :EMI :MEASure :DETEctor :DWELl <time></code> <code>[:SENSe] :EMI :MEASure :DETEctor :DWELl?</code>
Preset:	200.0 ms
Min:	4.0 ms
Max:	2000.0 s
State Saved:	Saved in instrument state
Example:	<code>:EMI:MEAS:DET:DWEL 200ms</code> <code>:EMI:MEAS:DET:DWEL?</code>

4 **Menu Maps**

These menu maps are in alphabetical order by the front- panel key label or oval cross-reference label. You can locate detailed information about each key/function at the page number listed in the figure title for each menu.

EMI Measurement Key Flow

The key flow diagrams, shown in a hierarchical manner on the following pages, explain the overall functional relationships for the front-panel keys and the softkeys displayed at the right side of the screen. The diagrams are:

- “File Key Flow (1 of 4)” on page 92
- “Input/Output Key Flow” on page 80
- “Marker Function Key Flow” on page 81
- “Measurement Selection Key Flow” on page 82
- “Measurement Setup Key Flow” on page 83
- “Mode Selection Key flow” on page 84
- “Mode Setup Selection Key Flow (1 of 6)” on page 85
- “System Key Flow” on page 91

Directions for Use

Refer to the following notes to utilize the key-flow diagrams:

- Start from the upper left corner of each measurement diagram. Go to the right, and go from the top to the bottom.
- When changing a key from auto (with underline) to manual, just press that key one time.
- When entering a numeric value for **Frequency**, a value with units, use the numeric keypad and terminate the entry with the appropriate unit selection from the softkeys displayed.
- When entering a numeric value for a unitless value, like **Avg Number**, use the numeric keypad and terminate the entry with the **Enter** front-panel key.
- Instead of using the numeric keypad to enter a value, it may be easier to use the front-panel knob or **Up/Down** arrow keys.

Table 4-1 Menu Map Legend





Icon	Description
	This represents the analyzer front-panel key.
	An oval represents additional levels of menus.
	This box shows how the softkey default condition is displayed. Default parameters or values are underlined wherever possible.
	A dagger to the left of a softkey indicates that when the key is pressed this is an active function.
	A double-dagger to the left of the softkey indicates a function that is not always available. It is dependent on other instrument settings.
	A bar on the left of two or more softkeys indicates that the keys are a mutually exclusive choice.

Figure 4-1 **Input/Output Key Flow**

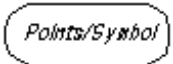

Menus
Input/Output Key

Figure 4-2 Marker Function Key Flow

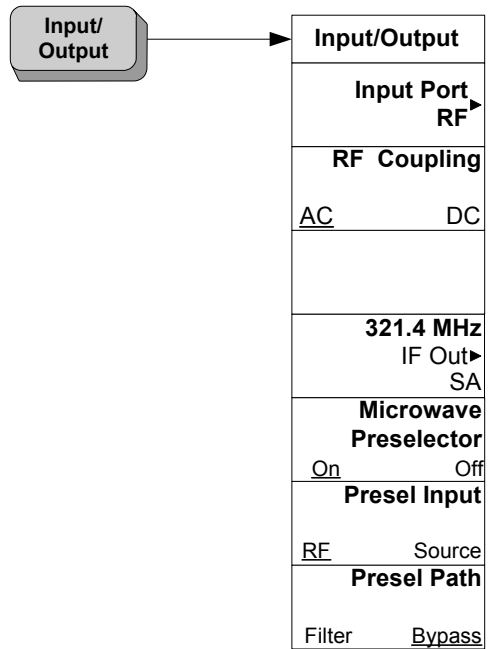
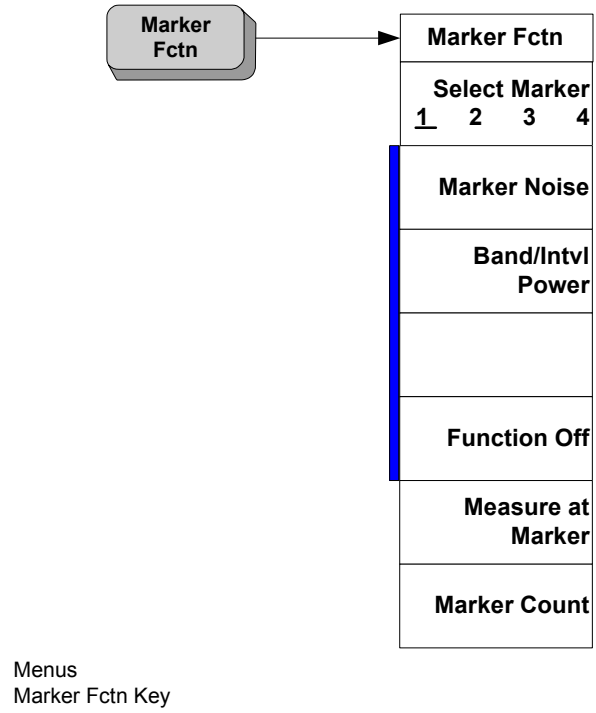
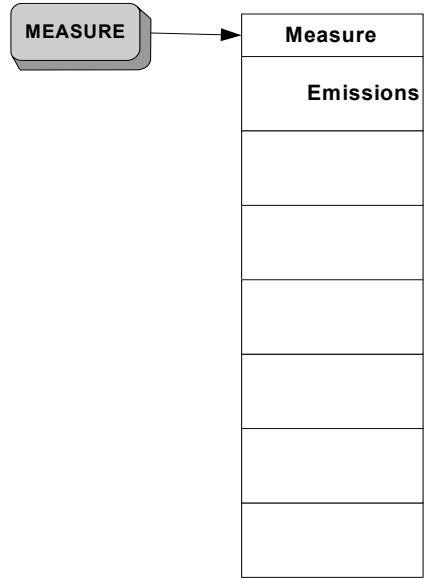

Figure 4-3 Measurement Selection Key Flow



Menus
Measure Key

Figure 4-4 Measurement Setup Key Flow

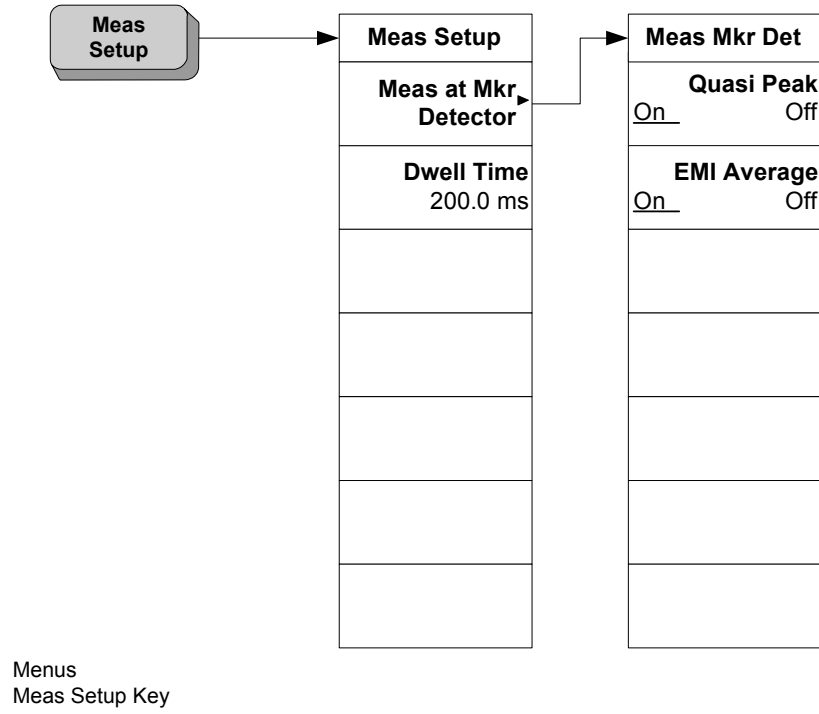

Figure 4-5 Mode Selection Key flow

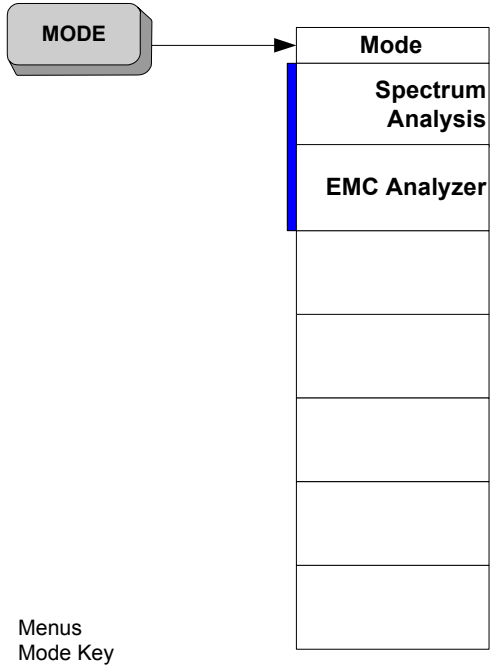

Figure 4-6 Mode Setup Selection Key Flow (1 of 6)

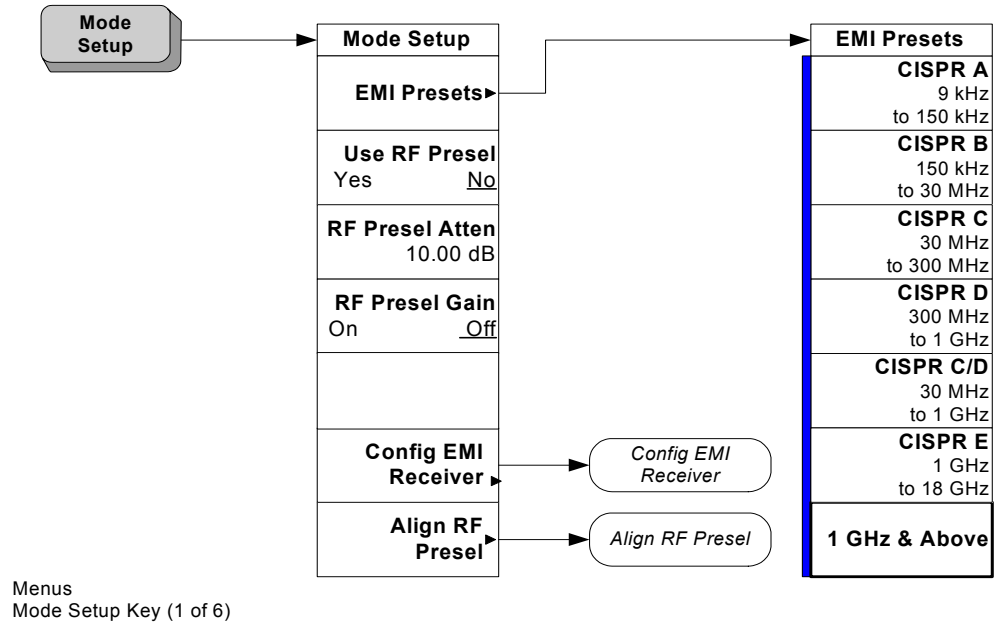
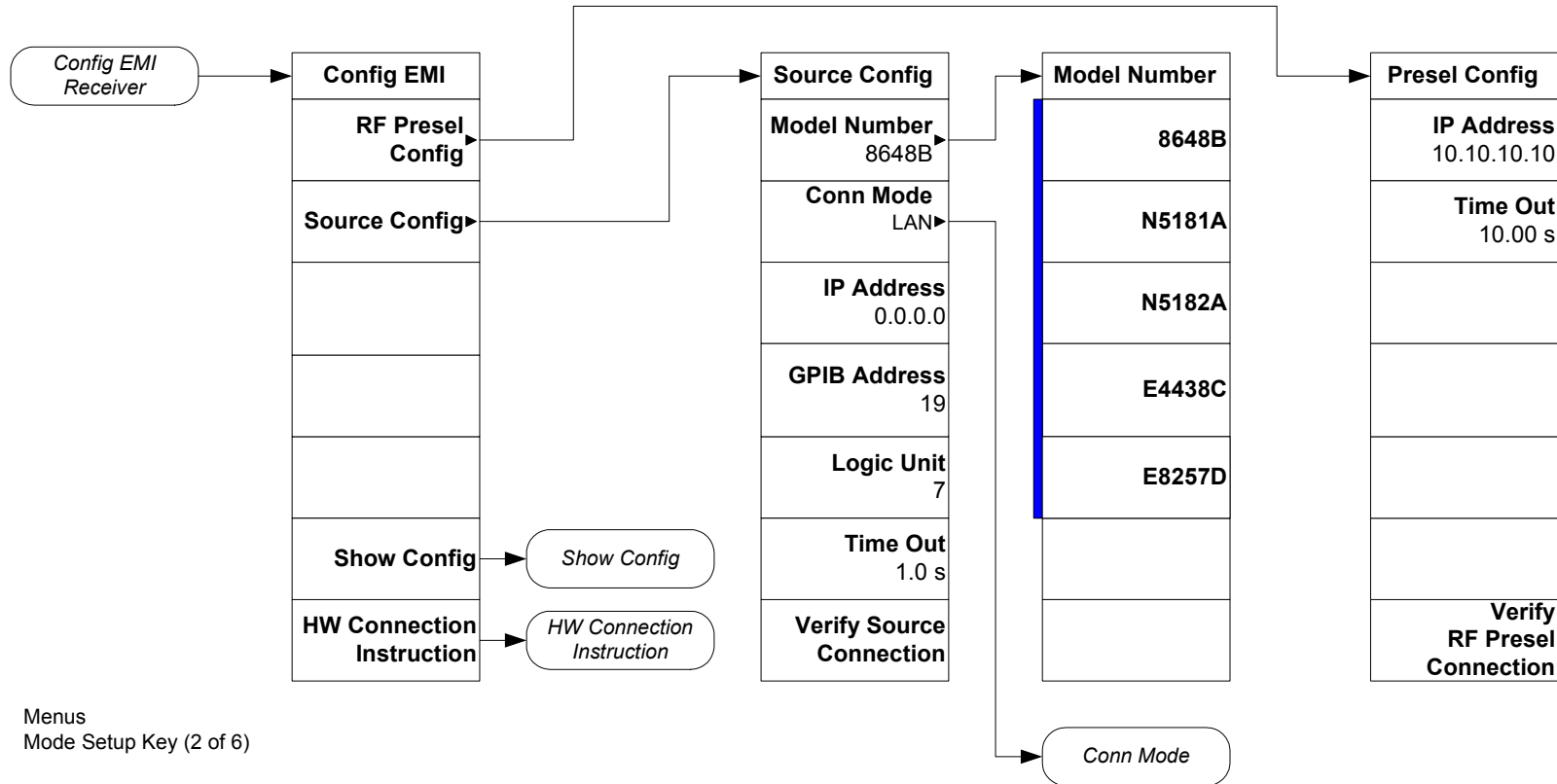

Figure 4-7 Mode Setup Selection Key Flow (2 of 6)



Menus
Mode Setup Key (2 of 6)

Figure 4-8 Mode Setup Selection Key Flow (3 of 6)

Figure 4-9 Mode Setup Selection Key Flow (4 of 6)



Menus
Mode Setup Key (4 of 6)

Figure 4-10 Mode Setup Selection Key Flow (5 of 6)

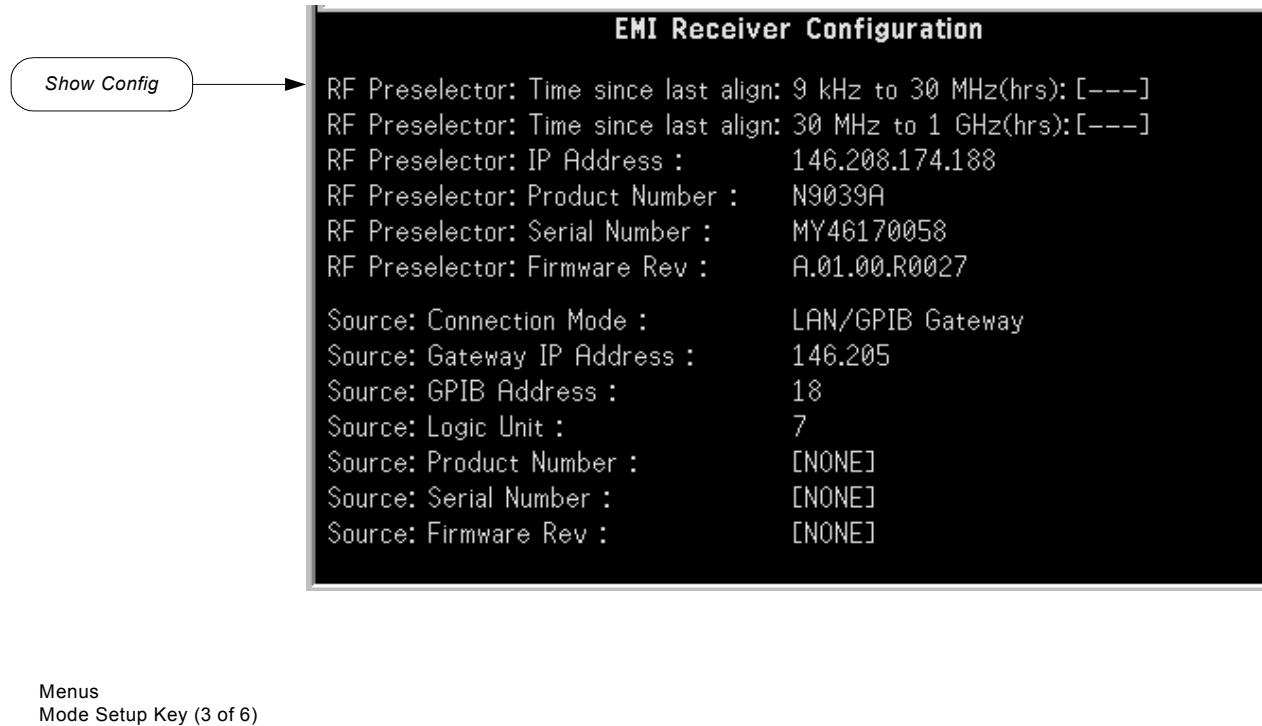
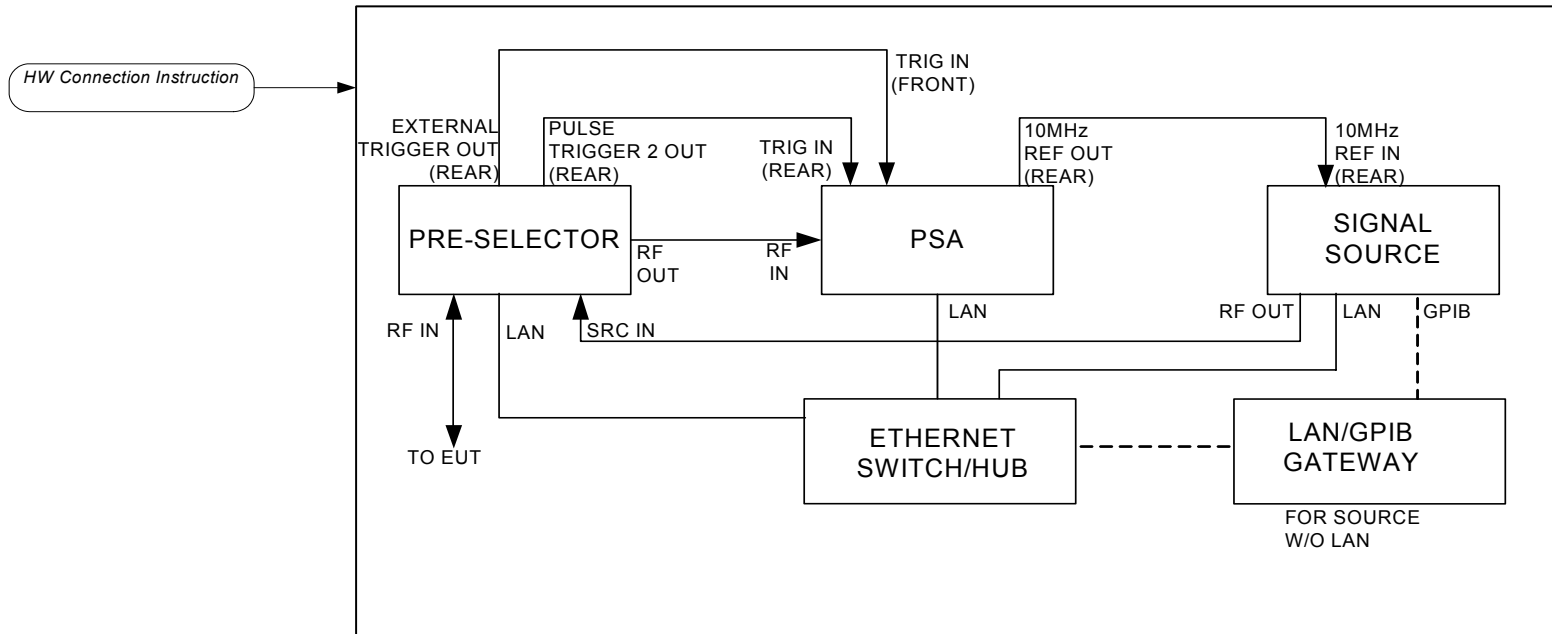
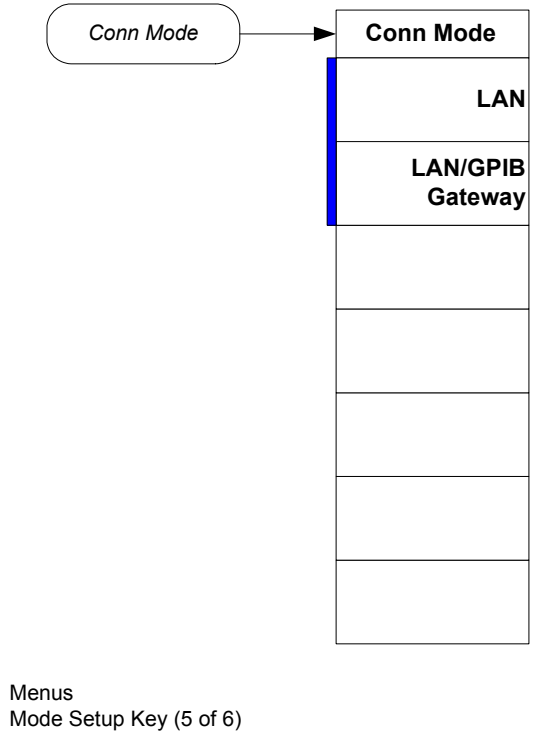
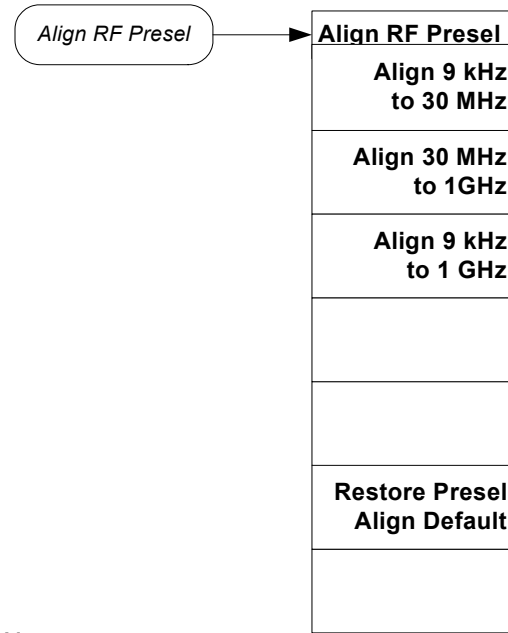

Figure 4-11 Mode Setup Selection Key Flow (6 of 6)



Menus
Mode Setup Key (6 of 6)

Figure 4-12 System Key Flow

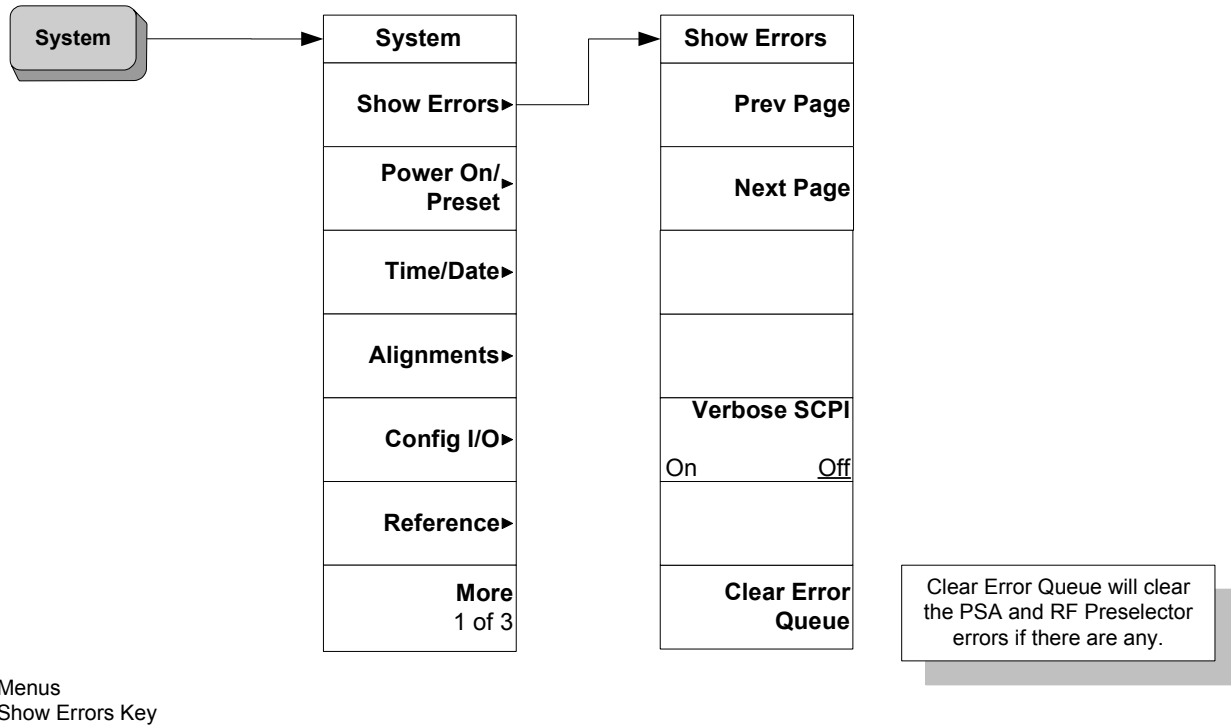
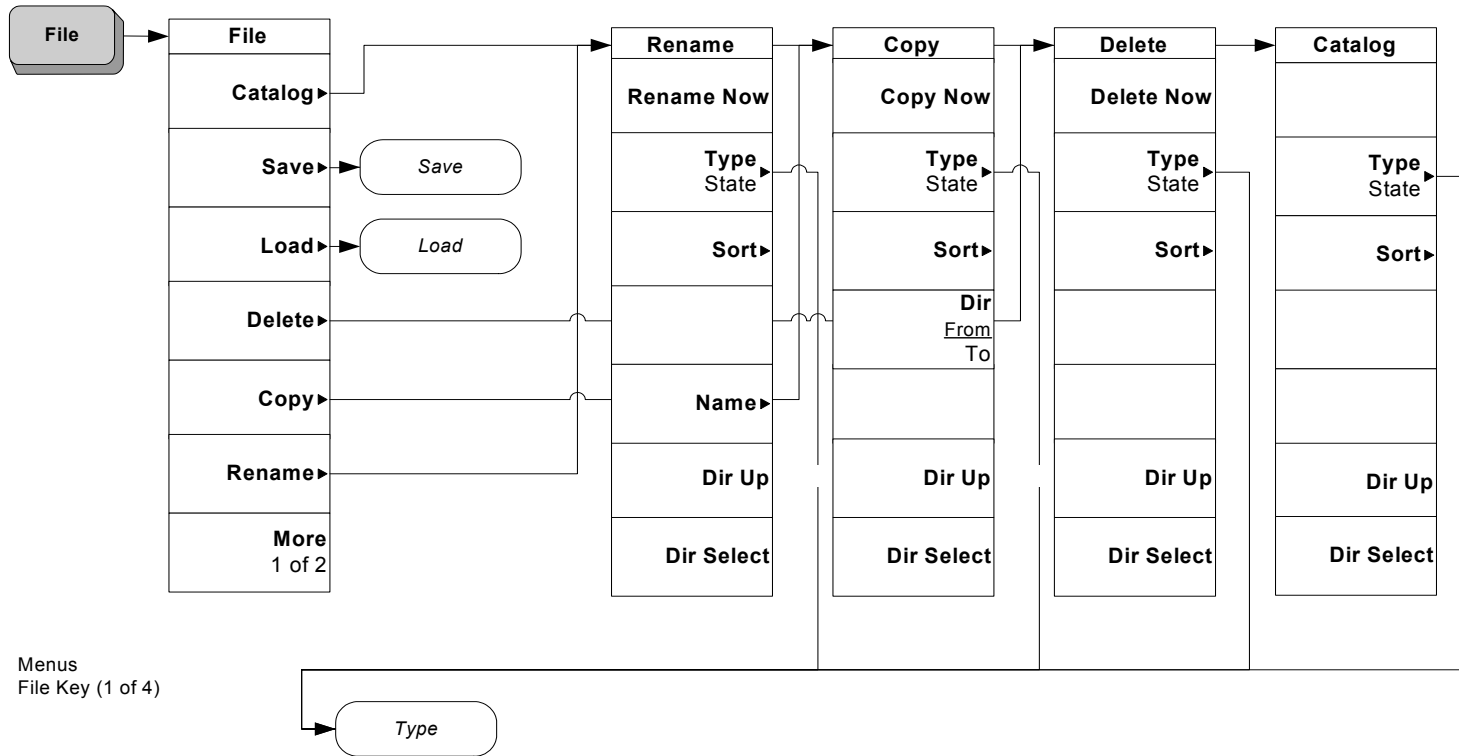
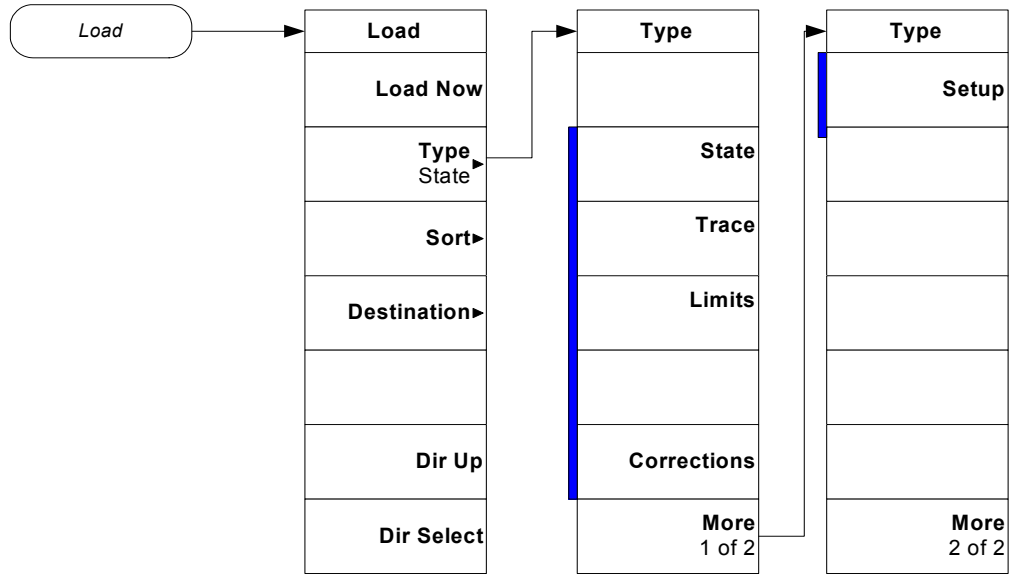

Figure 4-13 File Key Flow (1 of 4)



Menus
File Key (1 of 4)

Figure 4-14 File Key Flow (2 of 4)



Menus
File Key (2 of 4)

Figure 4-15 File Key Flow (3 of 4)

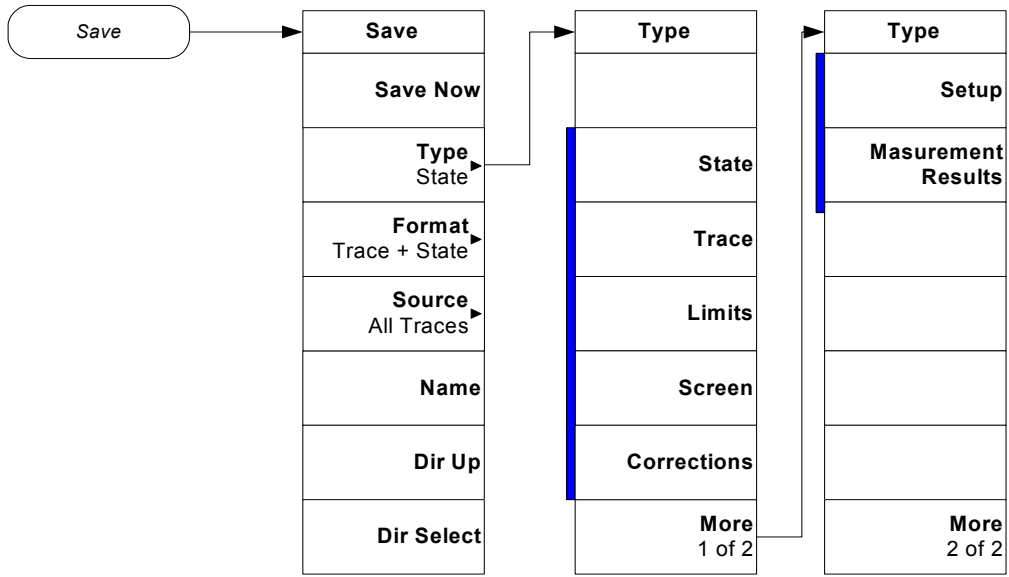

Menus
File Key (3 of 4)

Figure 4-16 **File Key Flow (4 of 4)**

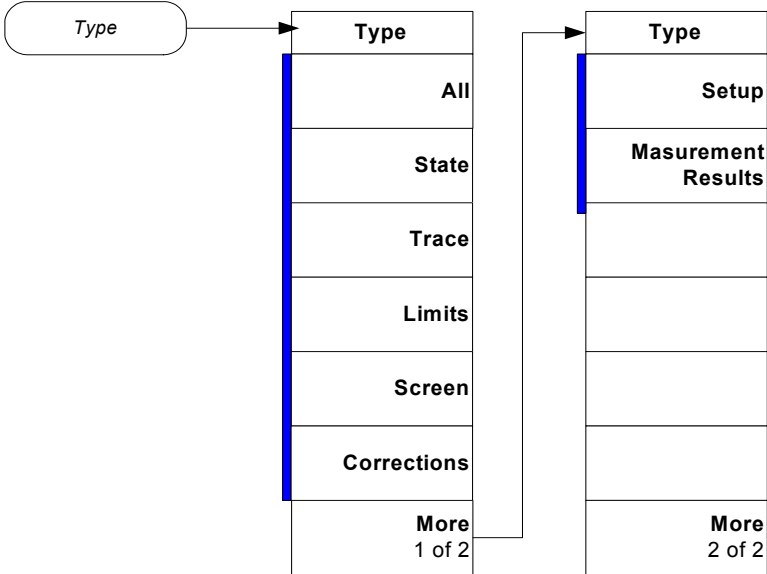

Menus
File Key (4 of 4)

A **Disk Contents: Limit Lines and
Transducer Factors**

Limit Line Table

Table A-1 *Limit Lines*

Description	Frequency Range	DOS Filename
AS/NZS 1044; Conducted Household Appliances, Quasi-Peak	150 kHz to 30 MHz	1044CHAQ.lim
AS/NZS 1044; Conducted Household Appliances, Average	150 kHz to 30 MHz	1044CHAA.lim
AS/NZS 1044; Conducted < 700 W, Motors, Quasi-Peak	150 kHz to 30 MHz	1044Cx7Q.lim
AS/NZS 1044; Conducted < 700 W, Motors, Average	150 kHz to 30 MHz	1044Cx7A.lim
AS/NZS 1044; Conducted > 700 W < 1000 W, Motors, Quasi-Peak	150 kHz to 30 MHz	1044Cx1Q.lim
AS/NZS 1044; Conducted > 700 W < 1000 W, Motors, Average	150 kHz to 30 MHz	1044Cx1A.lim
AS/NZS 1044; Conducted > 1000 W, Motors, Quasi-Peak	150 kHz to 30 MHz	1044C1xQ.lim
AS/NZS 1044; Conducted > 1000 W, Motors, Average	150 kHz to 30 MHz	1044C1xA.lim
AS/NZS 1044; Radiated Household Appliances, Quasi-Peak	30 MHz to 300 MHz	1044RHAQ.lim
AS/NZS 1044; Radiated Household Appliances, Average	30 MHz to 300 MHz	1044RHAA.lim
AS/NZS 1044; Radiated < 700 W, Motors, Quasi-Peak	30 MHz to 300 MHz	1044Rx7Q.lim
AS/NZS 1044; Radiated < 700 W, Motors, Average	30 MHz to 300 MHz	1044Rx7A.lim
AS/NZS 1044; Radiated > 700 W < 1000 W, Motors, Quasi-Peak	30 MHz to 300 MHz	1044Rx1Q.lim
AS/NZS 1044; Radiated > 700 W < 1000 W, Motors, Average	30 MHz to 300 MHz	1044Rx1A.lim
AS/NZS 1044; Radiated > 1000 W, Motors, Quasi-Peak	30 MHz to 300 MHz	1044R1xQ.lim
AS/NZS 1044; Radiated > 1000 W, Motors, Average	30 MHz to 300 MHz	1044R1xA.lim
AS/NZS 2064; Class A Conducted, Group 1, Average	150 kHz to 30 MHz	2064AC1A.lim
AS/NZS 2064; Class A Conducted, Group 1, Quasi-Peak	150 kHz to 30 MHz	2064AC1Q.lim
AS/NZS 2064; Class A Conducted, Group 2, Average	150 kHz to 30 MHz	2064AC2A.lim

Table A-1 Limit Lines (Continued)

Description	Frequency Range	DOS Filename
AS/NZS 2064; Class A Conducted, Group 2, Quasi-Peak	150 kHz to 30 MHz	2064AC2Q.lim
AS/NZS 2064; Class B Conducted, Group 1 and 2, Quasi-Peak	150 kHz to 30 MHz	2064BCQ.lim
AS/NZS 2064; Class B Conducted, Group 1 and 2, Average	150 kHz to 30 MHz	2064BCA.lim
AS/NZS 2064; Class A Radiated, Group 1	30 MHz to 1 GHz	2064AR1.lim
AS/NZS 2064; Class A Radiated, Group 2	150 kHz to 1 GHz	2064AR2.lim
AS/NZS 2064; Class B Radiated, Group 1	30 MHz to 1 GHz	2064BR1.lim
AS/NZS 2064; Class B Radiated, Group 2	30 MHz to 1 GHz	2064BR2.lim
AS/NZS 3548; Class A Conducted, Quasi-Peak	150 kHz to 30 MHz	548ACQP.lim
AS/NZS 3548; Class A Conducted, Average	150 kHz to 30 MHz	3548ACAV.lim
AS/NZS 3548; Class B Conducted, Quasi-Peak	150 kHz to 30 MHz	3548BCQP.lim
AS/NZS 3548; Class B Conducted, Average	150 kHz to 30 MHz	3548BCAV.lim
AS/NZS 3548; Class A Radiated (10m)	30 MHz to 1 GHz	3548AR10.lim
AS/NZS 3548; Class A Radiated (30m)	30 MHz to 1 GHz	3548AR30.lim
AS/NZS 3548; Class B Radiated (10m)	30 MHz to 1 GHz	3548BR10.lim
BellCore 1089; Conducted, Analog Voiceband Leads (Longitudinal)	8 kHz to 6 MHz	1089CVBL.lim
BellCore 1089; Conducted, Analog Voiceband Leads (Metallic)	8 kHz to 6 MHz	1089CVBM.lim
BellCore 1089; Class A Conducted, AC Power Leads (Quasi-Peak)	450 kHz to 69.5 MHz	1089CAPQ.lim
BellCore 1089; Class A Conducted, AC Power Leads - Voltage	450 kHz to 69.5 MHz	1089CAPV.lim
BellCore 1089; Class B Conducted, AC Power Leads - Voltage	450 kHz to 47.9 MHz	1089CBPV.lim
BellCore 1089; Radiated (3m) - Doors Open	10 kHz to 10 GHz	1089R3DO.lim
BellCore 1089; Radiated (3m) - Doors Closed	10kHz to 10 GHz	1089R3DC.lim
BellCore 1089; Radiated (10m) - Doors Open	10 kHz to 10 GHz	1089R1DO.lim
BellCore 1089; Radiated (10m) - Doors Closed	10 kHz to 10 GHz	1089R1DC.lim
EN 55011; Class A Conducted, Group 1, Quasi-Peak	150 kHz to 30 MHz	EN11AC1Q.lim
EN 55011; Class A Conducted, Group 1, Average	150 kHz to 30 MHz	EN11AC1A.lim

Table A-1 Limit Lines (Continued)

Description	Frequency Range	DOS Filename
EN 55011; Class A Conducted, Group 2, Quasi-Peak	150 kHz to 30 MHz	EN11AC2Q.lim
EN 55011; Class A Conducted, Group 2, Average	150 kHz to 30 MHz	EN11AC2A.lim
EN 55011; Class B Conducted, Group 1 and 2, Quasi-Peak	150 kHz to 30 MHz	EN11BCQ.lim
EN 55011; Class B Conducted, Group 1 and 2, Average	150 kHz to 30 MHz	EN11BCA.lim
EN 55011; Class A Radiated, Group 1	30 MHz to 1 GHz	EN11AR1.lim
EN 55011; Class A Radiated, Group 2	150 kHz to 1 GHz	EN11AR2.lim
EN 55011; Class B Radiated, Group 1	30 MHz to 1 GHz	EN11BR1.lim
EN 55011; Class B Radiated, Group 2	30 MHz to 1 GHz	EN11BR2.lim
EN 55014; Conducted Household Appliances, Quasi-Peak	150 kHz to 30 MHz	EN14CHAQ.lim
EN 55014; Conducted Household Appliances, Average	150 kHz to 30 MHz	EN14CHAA.lim
EN 55014; Conducted < 700 W, Motors, Quasi-Peak	150 kHz to 30 MHz	EN14Cx7Q.lim
EN 55014; Conducted < 700 W, Motors, Average	150 kHz to 30 MHz	EN14Cx7A.lim
EN 55014; Conducted > 700 W < 1000 W, Motors, Quasi-Peak	150 kHz to 30 MHz	EN14Cx1Q.lim
EN 55014; Conducted > 700 W < 1000 W, Motors, Average	150 kHz to 30 MHz	EN14Cx1A.lim
EN 55014; Conducted > 1000 W, Motors, Quasi-Peak	150 kHz to 30 MHz	EN14C1xQ.lim
EN 55014; Conducted > 1000 W, Motors, Average	150 kHz to 30 MHz	EN14C1xA.lim
EN 55014; Radiated Household Appliances, Quasi-Peak	30 MHz to 300 MHz	EN14RHAQ.lim
EN 55014; Radiated Household Appliances, Average	30 MHz to 300 MHz	EN14RHAA.lim
EN 55014; Radiated < 700 W, Motors, Quasi-Peak	30 MHz to 300 MHz	EN14Rx7Q.lim
EN 55014; Radiated < 700 W, Motors, Average	30 MHz to 300 MHz	EN14Rx7A.lim
EN 55014; Radiated > 700 W < 1000 W, Motors, Quasi-Peak	30 MHz to 300 MHz	EN14Rx1Q.lim
EN 55014; Radiated > 700 W < 1000 W, Motors, Average	30 MHz to 300 MHz	EN14Rx1A.lim
EN 55014; Radiated > 1000 W, Motors, Quasi-Peak	30 MHz to 300 MHz	EN14R1xQ.lim
EN 55014; Radiated > 1000 W, Motors, Average	30 MHz to 300 MHz	EN14R1xA.lim

Table A-1 Limit Lines (Continued)

Description	Frequency Range	DOS Filename
EN 55022; Class A Conducted, Quasi-Peak	150 kHz to 30 MHz	EN22ACQP.lim
EN 55022; Class A Conducted, Average	150 kHz to 30 MHz	EN22ACAV.lim
EN 55022; Class B Conducted, Quasi-Peak	150 kHz to 30 MHz	EN22BCQP.lim
EN 55022; Class B Conducted, Average	150 kHz to 30 MHz	EN22BCAV.lim
EN 55022; Class A Radiated (10m)	30 MHz to 1 GHz	EN22AR10.lim
EN 55022; Class A Radiated (30m)	30 MHz to 1 GHz	EN22AR30.lim
EN 55022; Class B Radiated (10m)	30 MHz to 1 GHz	EN22BR10.lim
FCC Part 15; Class A Conducted	450 kHz to 30 MHz	FCC15AC.lim
FCC Part 15; Class B Conducted	450 kHz to 30 MHz	FCC15BC.lim
FCC Part 15; Class A Radiated (10m)	30 MHz to 5 GHz	FCC15A10.lim
FCC Part 15; Class B Radiated (3m)	30 MHz to 40 GHz	FCC15B3.lim
FCC Part 15; Class B Radiated (10m)	30 MHz to 5 GHz	FCC15B10.lim
GB9254 1998; Conducted Class A, Quasi-Peak	150 kHz to 30 MHz	G9254CAQ.lim
GB9254 1998; Conducted Class A, Average	150 kHz to 30 MHz	G9254CAA.lim
GB9254 1998; Conducted Class B, Quasi-Peak	150 kHz to 30 MHz	G9254CBQ.lim
GB9254 1998; Conducted Class B, Average	150 kHz to 30 MHz	G9254CBA.lim
GB9254 1998; Radiated Class A	30 MHz to 1 GHz	G9254RA.lim
GB9254 1998; Radiated Class B	30 MHz to 1 GHz	G9254RB.lim
VCCI; Conducted Class 1, Quasi-Peak	150 kHz to 30 MHz	VCCIC1QP.lim
VCCI; Conducted Class 1, Average	150 kHz to 30 MHz	VCCIC1AV.lim
VCCI; Conducted Class 2, Quasi-Peak	150 kHz to 30 MHz	VCCIC2QP.lim
VCCI; Conducted Class 2, Average	150 kHz to 30 MHz	VCCIC2AV.lim
VCCI; Radiated Class 1 (3m)	30 MHz to 1 GHz	VCCIR13.lim
VCCI; Radiated Class 1 (10m)	30 MHz to 1 GHz	VCCIR110.lim
VCCI; Radiated Class 2 (10m)	30 MHz to 1 GHz	VCCIR210.lim
MIL-STD CE101-1 Conducted, Power Leads	30 Hz to 10 kHz	MC101X1.lim
MIL-STD CE101-2 Conducted, Power Leads, <1kVA	30 Hz to 10 kHz	MC101X2A.lim
MIL-STD CE101-2 Conducted, Power Leads, ≥1kVA	30 Hz to 10 kHz	MC101X2B.lim
MIL-STD CE101-3 Conducted, Power Leads, 400 Hz, <0.2 kVA	30 Hz to 10 kHz	MC101X3A.lim

Table A-1 Limit Lines (Continued)

Description	Frequency Range	DOS Filename
MIL-STD CE101-3 Conducted, Power Leads, 400 Hz, ≥ 0.2 kVA	30 Hz to 10 kHz	MC101X3B.lim
MIL-STD CE101-4 Conducted, Power Leads, >28 V	30 Hz to 10 kHz	MC101X4A.lim
MIL-STD CE101-4 Conducted, Power Leads, ≤ 28 V	30 Hz to 10 kHz	MC101X4B.lim
MIL-STD CE102-1 Conducted, Power Leads	10 kHz to 10 MHz	MC102X1.lim
MIL-STD RE101-1 Radiated, Magnetic Field, Army applications	30 Hz to 100 kHz	MR101X1.lim
MIL-STD RE101-2 Radiated, Magnetic Field, Navy applications	30 Hz to 100 kHz	MR101X2.lim
MIL-STD RE102-1 Radiated, Electric Field, surface ship	10 kHz to 18 GHz	MR102X1.lim
MIL-STD RE102-2 Radiated, Electric Field, submarine internal	10 kHz to 18 GHz	MR102X2A.lim
MIL-STD RE102-2 Radiated, Electric Field, submarine external	10 kHz to 18 GHz	MR102X2B.lim
MIL-STD RE102-3 Radiated, Electric Field, fixed wing external	10 kHz to 18 GHz	MR102X3A.lim
MIL-STD RE102-3 Radiated, Electric Field, aircraft, ≥ 25 m	10 kHz to 18 GHz	MR102X3B.lim
MIL-STD RE102-3 Radiated, Electric Field, aircraft, <25 m	10 kHz to 18 GHz	MR102X3C.lim
MIL-STD RE102-4 Radiated, Electric Field, Navy Fixed & AF	10 kHz to 18 GHz	MR102X4A.lim
MIL-STD RE102-4 Radiated, Electric Field, Navy Mobile & AF	10 kHz to 18 GHz	MR102X4B.lim

Transducer Factors Table

Table A-2 Transducer Factors

Description	DOS Filename
Agilent 11909A; Preamplifier (9 kHz to 1 GHz)	11909A.amp
Agilent 11940A; Close Field Probe (30 MHz to 1 GHz)	11940A.ant
Agilent 11941A; Close Field Probe (9 kHz to 30 MHz)	11941A.ant
Agilent 11947A; Transient Limiter (9 kHz to 200 MHz)	11947A.amp
Agilent 11955A; Biconical Antenna (30 MHz to 300 MHz)	11955A.ant
Agilent 11956A; Log Periodic Antenna (200 MHz to 1 GHz)	11956A1G.ant
Agilent 11956A; Log Periodic Antenna (200 MHz to 2 GHz) ^a	11956A2G.ant
Agilent 11966A; Active Loop Antenna (10 kHz to 30 MHz)	11966A.ant
Agilent 11966B; Active Monopole Antenna (30 Hz to 50 MHz)	11966B.ant
Agilent 11966C; Biconical Antenna (30 MHz to 300 MHz)	11966C.ant
Agilent 11966D; Log Periodic Antenna (200 MHz to 1 GHz)	11966D1G.ant
Agilent 11966D; Log Periodic Antenna (200 MHz to 2 GHz) ^a	11966D2G.ant
Agilent 11966E; Double Ridged Horn Antenna (1 GHz to 18 GHz)	11966E.ant
Agilent 11966F; Conical Log Spiral Antenna (200 MHz to 1 GHz)	11966F.ant
Agilent 11966G; Conical Log Spiral Antenna (1 GHz to 10 GHz)	11966G.ant
Agilent 11966H; Dipole Antenna Set (28 MHz to 1 GHz)	
Balun 1, (28 MHz to 60 MHz)	11966HB1.ant
Balun 2, (60 MHz to 140 MHz)	11966HB2.ant
Balun 3, (140 MHz to 400 MHz)	11966HB3.ant
Balun 4, (400 MHz to 1 GHz)	11966HB4.ant
Agilent 11966I; Double Ridged Horn Antenna (200 MHz to 2 GHz)	11966I.ant
Agilent 11966J; Horn Antenna (18 GHz to 40 GHz)	11966J.ant
Agilent 11966K; Magnetic Field Pickup Coil (20 Hz to 50 kHz)	11966K.ant
Agilent 11966L; Coaxial Cable (Type-N)	11966L.cbl
Agilent 11966N; Log Periodic Antenna (200 MHz to 5 GHz)	11966N.ant
Agilent 11966P; Broadband Antenna (30 MHz to 1 GHz)	11966P1G.ant
Agilent 11966P; Broadband Antenna (30 MHz to 3 GHz) ^b	11966P3G.ant

Table A-2 Transducer Factors

Description	DOS Filename
Agilent 11967C; LISN (25 A)	11967C.ant
Agilent 11967D; LISN (10 A)	11967D.ant
Agilent 11967E; LISN (25 A)	11967E.ant
Agilent 83017A; Amplifier (500 MHz to 26.5 GHz)	83017A.amp
Agilent 83018A; Amplifier (1 GHz to 26.5 GHz)	83018A.amp
Agilent 83020A; Amplifier (1 GHz to 26.5 GHz)	83020A.amp
Agilent 83050A; Amplifier (2 GHz to 50 GHz)	83050A.amp
Agilent 8447F, Option H64; Dual Preamp	
Band 1, (9 kHz to 50 MHz)	8447FLO.amp
Band 2, (100 kHz to 1.3 GHz)	8447FHI.amp
Agilent 87405A; Amplifier (45 MHz to 3 GHz)	87405A.amp
Agilent 87415A; Amplifier (2 GHz to 8 GHz)	87415A.amp

- a. Currently selling versions have an upper frequency limit of 2 GHz. Earlier models have an upper frequency limit of only 1 GHz. Refer to the information for your antenna to determine which correction file to use.
- b. Currently selling versions have an upper frequency limit of 3 GHz. Earlier models have an upper frequency limit of only 1 GHz. Refer to the information for your antenna to determine which correction file to use.

A

active license key, 16
 how to locate, 16
align 30 mhz to 1 ghz key, 28, 69
align 9 khz to 1 ghz key, 28, 70
align 9 khz to 30 mhz key, 28, 69
align all now key, 27
align rf preselect key, 28, 69
 align 30 mhz to 1 ghz, 28
 align 9 khz to 1 ghz, 28
 align 9 khz to 30 mhz, 28
 restore preselect align default, 28
aligning the system, 27
alignment needed example, 29
alignments key, 27
 align all now, 27

C

center freq key, 39, 43
center frequency key, 54
Choose Option key, 16
CISPR
 conducted band, 10
 full-compliance measurement, 10
 pre-compliance measurement, 10
 radiated band, 10
commands
 CONFigure, 72
 FETCh, 73
 MEASure, 72
 READ, 73, 74
conducted emissions testing, 10
config emi receiver key, 25, 26, 63
 rf preselect config, 25
 show config, 26
 source config, 26
config i/o key, 25
 ip address, 25
config key
 gateway address, 25
 subnet mask, 25
CONFigure commands, 72
configuring the system, 25
conn mode key, 26, 66
connecting the system, 22

D

default values, setting remotely, 72
deleting an
 application/personality, 11
dir select key, 44
dir up key, 44
display key, 36, 42

limits, 36, 42
dwell time, 76
dwell time key, 40, 43

E

emc analyzer key, 25, 35, 41, 60
emi average key, 39, 43, 75
emi presets, 34
emi presets key, 36, 41, 61
EMI receiver, 10
EMI receiver system, 10
emissions, 75
emissions key, 74
equipment setup, 22
equipment setup diagram
 connecting the system using lan, 23
 connecting the system using lan/gpib, 24
error code
 cal source signal missing, check all the connections, 49
 connection with preselect could not be established, 46
 connection with source could not be established, 46
 connection with source could not be established at the ip/gpib, 47
 freq crossing of conducted and radiated bands is not supported, 48
 not available when zoomed graph selected, 49
 rf preselect input is overloaded, 48
 rf preselect model is not supported, 46
 rf preselector alignment required 30 MHz to 1 GHz, 48
 rf preselector alignment required 9 kHz to 1 GHz, 47
 rf preselector alignment required 9 kHz to 30 MHz, 47
 rf preselector alignment terminated by user, 48
 rf preselector changed, new alignment required, 49
 rf preselector conducted band alignment failed, 48
 rf preselector radiated band alignment failed, 48
 source model is not supported, 47
error codes, 46

F

factory key, 30
factory preset settings, 31
FETCh commands, 73
file key, 44, 45, 56
 load, 44, 45
 save, 44
file operation, 44
 loading a corrections file, 45
 loading a limit file, 45
 loading a setup file, 44
 saving a setup file, 44
front panel key
 display, 36, 42
 file, 44, 45
 frequency channel
 center freq, 39, 43
 input/output, 35, 41
 marker fctn, 40, 43, 58
 meas control, 59
 meas setup, 39, 43, 75
 measure, 71
 mode, 25, 35, 41, 60
 mode setup, 25, 26, 28, 35, 41, 61
 next window, 39, 43
 preset, 30, 32, 33
 span x scale
 span, 39, 43
 system, 25, 27, 70
 zoom, 38, 43

G

gateway address key, 25
gpib address key, 26, 66

H

hw connection instruction key, 68

I

input/output key, 35, 41
 preselect path, 35, 36, 41, 42
Install Now key, 16
Installing and Obtaining a license key, 15
installing measurement personalities, 11
instrument requirements, 21
ip address key, 25, 26, 63, 66

L

license key
 obtaining and installing, 15
limit 1 key, 36, 42
limits

- limit 1
 - limit display, 36, 42
 - limit test, 36, 42
- limits key, 36, 42
- limit 1, 36, 42
- load key, 44, 45, 56
 - load now, 44, 45
 - type, 44, 45
- loading a corrections file, 45
- loading a limit file, 45
- loading a setup file, 44
- loading an
 - application/personality, 11
- logic unit key, 26, 67
- M**
- major functional keys, 52
- making emissions measurement, 34
- making measurements, 19
 - aligning the system, 27
 - conducted emissions measurements, 35
 - configuring the system, 25
 - connecting the system, 22
 - error codes, 46
 - file operation, 44
 - procedure, 34
 - radiated emissions measurements, 41
 - using instrument presets, 30
- marker fctn key, 40, 43, 58
- measure at marker, 40, 43
- meas at mrk detector key, 39, 43
 - emi average, 39, 43
 - quasi peak, 39, 43
- Meas Control key, 59
- meas control key
 - measure, 59
 - cont, 59
 - single, 59
 - pause, 60
 - resume, 60
 - restart, 59
- meas setup key, 39, 43, 75
 - dwll time, 40, 43
 - meas at mkr detector, 39, 43
 - measure at marker, 58
 - measure at marker key, 40, 43
- MEASure commands, 72
- MEASURE key
 - Transmit Power key, 75
 - measure key, 71
 - emissions, 74
 - measurement key flow, 78
 - measurements
 - setting default values remotely, 72
- missing options, 11
- mode key, 25, 35, 41, 60
 - emc analyzer, 25, 35, 41, 60
 - spectrum analysis, 60
- mode preset settings, 32
- mode setup key, 25, 26, 28, 35, 41, 61
 - align rf presel, 28
 - config emi receiver, 25, 26
 - emi presets, 36, 41
 - rf presel att, 36, 41
 - rf presel gain, 37, 42
 - use rf presel, 35, 36, 41
- model number key, 26, 65
- N**
- name key, 44
- next window key, 39, 43
- O**
- options
 - loading/deleting, 11
- options not in instrument memory, 11
- P**
- personality options not in instrument, 11
- power on/preset key
 - preset type, 30
- presel input key, 57
- presel path key, 35, 36, 41, 42, 57
- preset key, 30, 32, 33
- preset type key, 30
 - factory, 30
- procedure
 - conducted emissions measurement, 35
 - loading a corrections file, 45
 - loading a limit file, 45
 - loading a setup file, 44
 - making the measurement, 34
 - radiated emissions measurement, 41
 - saving a setup file, 44
- psa frequency ranges, 30
- psa model number, 30
- Q**
- quasi peak key, 39, 43, 75
- R**
- radiated emissions testing, 10
- READ commands, 73, 74
- restart key, 59
- restore presel align default key, 28, 70
- rf presel att, 62
- rf presel att key, 36, 41
- rf presel config, 63
- rf presel config key
 - ip address, 25
 - time out, 25
 - verify rf presel connection, 26
- rf presel gain key, 37, 42, 63
- rf presel key, 25
- S**
- save key, 44, 56
 - dir select, 44
 - dir up, 44
 - name, 44
 - type, 44
- saving a setup file, 44
- show config key, 26, 68
- show error key, 70
- source config key, 26, 65
 - conn mode, 26
 - gpib address, 26
 - ip address, 26
 - logic unit, 26
 - model number, 26
 - time out, 26
 - verify source connection, 26
- span key, 55
- spectrum analysis key, 60
- subnet mask key, 25
- system key, 25, 27, 70
 - alignments, 27
 - config i/o, 25
 - power on/preset, 30
 - show error, 70
- T**
- test equipment setup
 - connecting the system, 22
- time out key, 25, 26, 64, 67
- Transmit Power key
 - MEASURE key, 75
- type key, 44, 45
 - corrections, 36, 42, 45
 - limits, 36, 42, 45
 - setup, 44
- U**
- Uninstall Now, 16
- uninstalling measurement personalities, 11
- use rf presel key, 35, 36, 41, 62

using instrument presets, [30](#)

V

verify rfpresel connection key, [26](#),
[64](#)

verify source connection key, [26](#),
[68](#)

Z

zoom key, [38](#), [43](#)

