

Agilent Technologies N5280A

User's and Service Guide

**Use this manual with the following document:
PNA Series Network Analyzer On-line Help System**



Manufacturing Part Number: N5280-90001

Printed in USA

Printed Date: April 2009

Supersede: March 2009

© Copyright 2008, 2009 Agilent Technologies, Inc. All rights reserved.

Warranty Statement

THE MATERIAL CONTAINED IN THIS DOCUMENT IS PROVIDED “AS IS,” AND IS SUBJECT TO BEING CHANGED, WITHOUT NOTICE, IN FUTURE EDITIONS. FURTHER, TO THE MAXIMUM EXTENT PERMITTED BY APPLICABLE LAW, AGILENT DISCLAIMS ALL WARRANTIES, EITHER EXPRESS OR IMPLIED WITH REGARD TO THIS MANUAL AND ANY INFORMATION CONTAINED HEREIN, INCLUDING BUT NOT LIMITED TO THE IMPLIED WARRANTIES OF MERCHANTABILITY AND FITNESS FOR A PARTICULAR PURPOSE. AGILENT SHALL NOT BE LIABLE FOR ERRORS OR FOR INCIDENTAL OR CONSEQUENTIAL DAMAGES IN CONNECTION WITH THE FURNISHING, USE, OR PERFORMANCE OF THIS DOCUMENT OR ANY INFORMATION CONTAINED HEREIN. SHOULD AGILENT AND THE USER HAVE A SEPARATE WRITTEN AGREEMENT WITH WARRANTY TERMS COVERING THE MATERIAL IN THIS DOCUMENT THAT CONFLICT WITH THESE TERMS, THE WARRANTY TERMS IN THE SEPARATE AGREEMENT WILL CONTROL.

DFARS/Restricted Rights Notice

If software is for use in the performance of a U.S. Government prime contract or subcontract, Software is delivered and licensed as “Commercial computer software” as defined in DFAR 252.227-7014 (June 1995), or as a “commercial item” as defined in FAR 2.101(a) or as “Restricted computer software” as defined in FAR 52.227-19 (June 1987) or any equivalent agency regulation or contract clause. Use, duplication or disclosure of Software is subject to Agilent Technologies’ standard commercial license terms, and non-DOD Departments and Agencies of the U.S. Government will receive no greater than Restricted Rights as defined in FAR 52.227-19(c)(1-2) (June 1987). U.S. Government users will receive no greater than Limited Rights as defined in FAR 52.227-14 (June 1987) or DFAR 252.227-7015 (b)(2) (November 1995), as applicable in any technical data.

Safety Notes

The following safety notes are used throughout this document. Familiarize yourself with each of these notes and its meaning before performing any of the procedures in this document.

WARNING **Warning denotes a hazard. It calls attention to a procedure which, if not correctly performed or adhered to, could result in injury or loss of life. Do not proceed beyond a warning note until the indicated conditions are fully understood and met.**

CAUTION Caution denotes a hazard. It calls attention to a procedure that, if not correctly performed or adhered to, could result in damage to or destruction of the instrument. Do not proceed beyond a caution sign until the indicated conditions are fully understood and met.

Statement of Compliance

This product has been designed and tested in accordance with the standards listed on the Manufacturer's Declaration of Conformity, and has been supplied in a safe condition. The documentation contains information and warnings that must be followed by the user to ensure safe operation and to maintain the product in a safe condition.

Definitions

- *Specifications* describe the performance of parameters covered by the product warranty (temperature –0 to 55 °C, unless otherwise noted.)
- *Typical* describes additional product performance information that is not covered by the product warranty. It is performance beyond specification that 80% of the units exhibit with a 95% confidence level over the temperature range 20 to 30 °C. Typical performance does not include measurement uncertainty.
- *Nominal* values indicate expected performance or describe product performance that is useful in the application of the product, but is not covered by the product warranty.
- *Characteristic Performance* describes performance parameter that the product is expected to meet before it leaves the factory, but is not verified in the field and is not covered by the product warranty. A characteristic includes the same guard bands as a specification.

Contents

N5280A

Introduction	2
Description	4
Network Analyzer Requirements	4
Available Options	6
Test Set Options	6
Verifying the Shipment	6
General Specifications	7
Power Requirements	8
Environmental Requirements	9
Environmental Tests	9
Equipment Heating and Cooling	9
Required Conditions for Accuracy Enhanced Measurement	9
Dimensions and Space Requirements	10
Maximum Power Levels	10
Front and Rear Panel Features	11
RF Input (A, B, C and D)	11
Line Switch	11
IF OUT (A, B, C/R1 and D/R2)	12
LO IN	12
LO AUX	12
Attenuators (A, B, C and D)	12
Line Module	12
Available Fuses	13
Controlling the Test Set with N5242A	14
Controlling the Test Set with N5264A	16
Controlling the RF Receiver Attenuators	20
Operational Check	22
Equipment Required	22
Verification Limits	23
Operational Check Procedure	26
Preparing the N5242A	26
Attenuator Element Verification Procedure	29
Service Information	32
Replaceable Parts	32
Safety and Regulatory Information	36
Introduction	36
Before Applying Power	36
Connector Care and Cleaning	36
Declaration of Conformity	36
Shipping Your Analyzer to Agilent for Service or Repair	36
Compliance with German Noise Requirements	37
EMC Information	37
Safety Information	37
Warnings	38
Cautions	39
Instrument Markings	40
Electrostatic Discharge Protection	41
Contacting Agilent Sales and Service Offices	42

Contents

N5280A

Introduction

The N5280A replaces the Hewlett Packard 8511A Four Channel Frequency Converter Test Set. This document describes how to use the N5280A Test Set with the Agilent N5242A 2-Port, or 4-Port PNA-X Network Analyzer and N5264A Measurement Receiver.

Figure 1 N5242A 2-Port PNA-X with N5280A



Figure 2 N5242A 4-Port PNA-X with N5280A

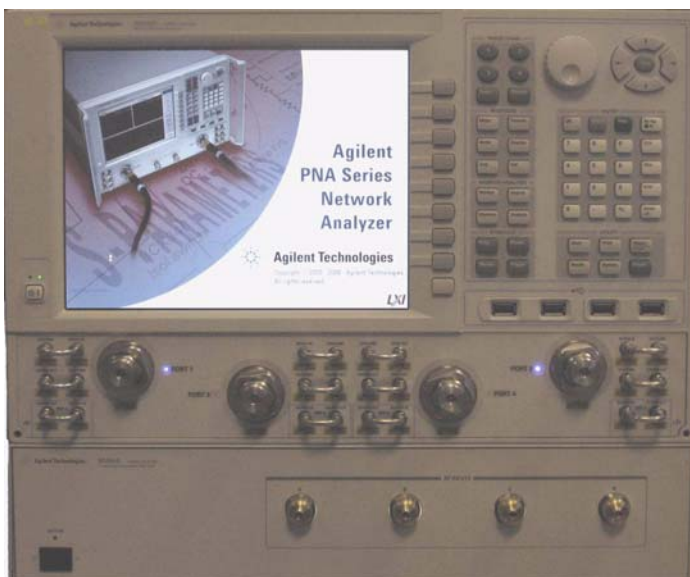
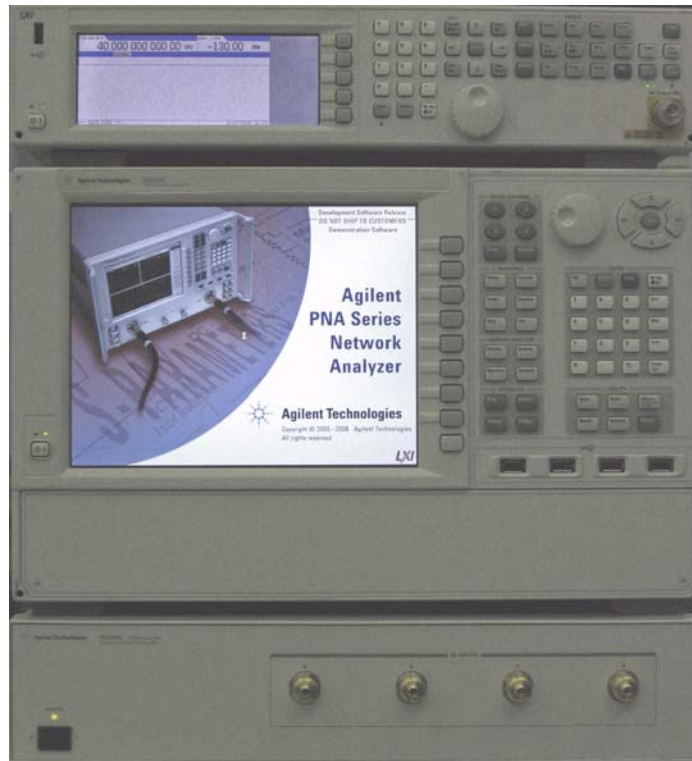

Figure 3 N5264A Measurement Receiver with N5280A



Description

The Agilent N5280A is a four channel frequency converter test set. This test set is used with the Agilent N5242A 2-Port or 4-Port PNA-X Network Analyzer, and a N5264A Measurement Receiver. It can be operated with other microwave accessories (couplers, power splitters). The N5280A provides a convenient means of customizing a test configuration for a variety of applications within a frequency range of 10 MHz to 26.5 GHz. In addition to configurations for measuring reflection and transmission parameters of one-port or two-port devices, you can build configurations to characterize antenna parameters, radar cross sections and frequency translation devices. [Figure 4 on page 5](#) illustrates one possible measurement set-up configuration.

Network Analyzer Requirements

- The N5242A 2-Port or 4-Port PNA-X Network Analyzer (10 MHz to 26.5 GHz) requires Option 020, which adds IF inputs.
- The N5264A Measurement Receiver requires Option 108, which adds LO Source 26.5 GHz.

More PNA information is available on the following websites:

- Documentation - <http://www.agilent.com/find/pna>
- Network Analyzer Firmware - <http://na.tm.agilent.com/pna/firmware/firmware.htm>

Figure 4 Measurement Setup

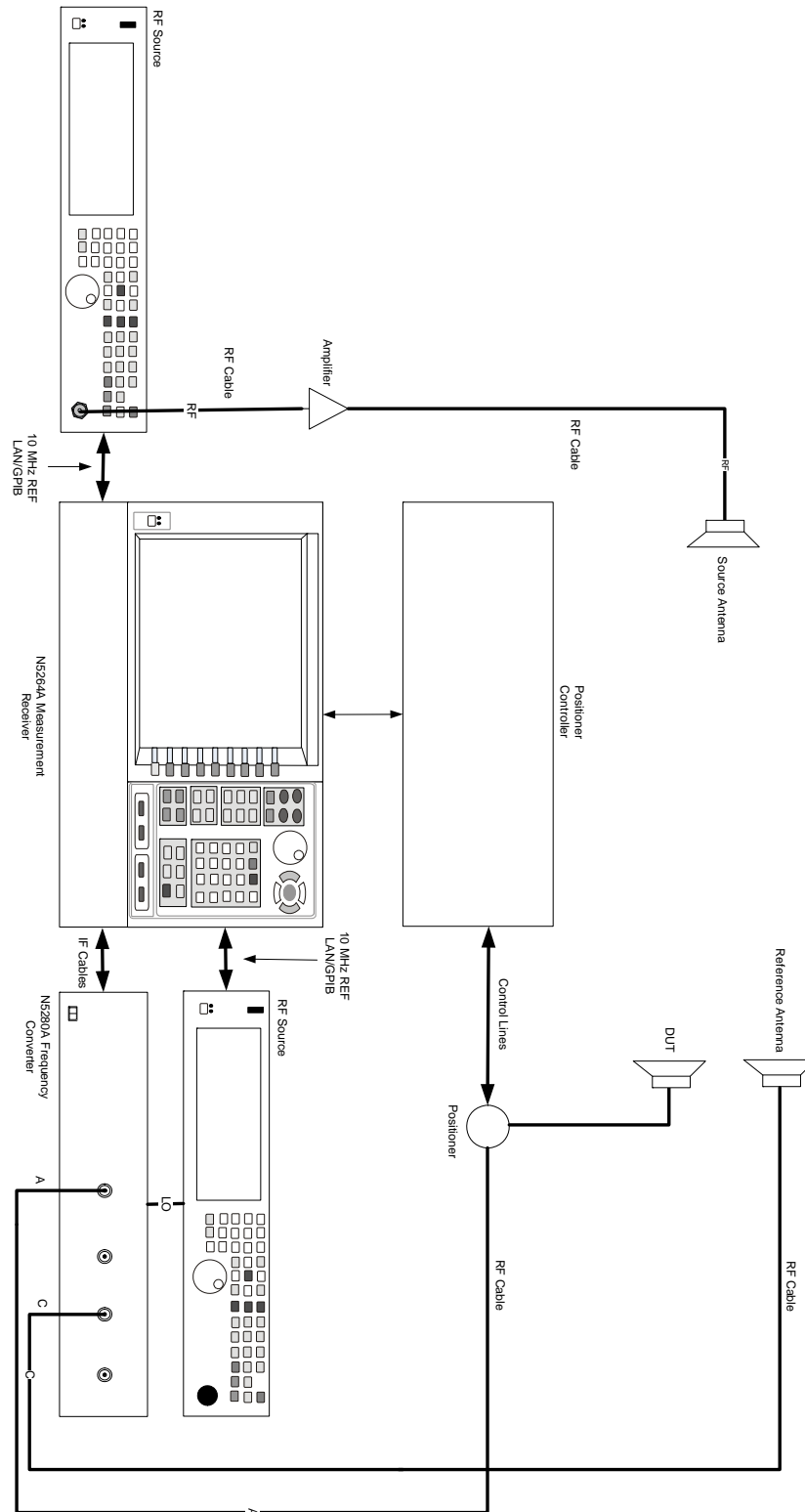

Available Options

Test Set Options

The N5280A has two available test set options:
Refer to [Figure 20 on page 30](#) and [Figure 21 on page 31](#).

- Standard (700)- There are no attenuators in the RF Input paths.
- Option 001 - There are four attenuators (0 to 35 dB) in RF Input paths to reduce the power levels.

Verifying the Shipment

Inspect the shipping container. If the container or packing material is damaged, it should be kept until the contents of the shipment have been checked mechanically and electrically. If there is physical damage refer to [“Contacting Agilent Sales and Service Offices” on page 42](#). Keep the damaged shipping materials (if any) for inspection by the carrier and an Agilent Technologies representative.

[Table 1](#) contains the accessories shipped with your N5280A.

Table 1 Content List

Agilent Part Number	Description	Qty
9320-6636	Functional Test Certificate	1
9320-0333	Envelope-Cal Certificate	1
5063-9232	Rack Mount Kit with Handles	1
5063-9226	Front Handle Kit	1
5061-9038	Cable Assembly	5
N5280-90001	User's Guide	1

General Specifications

Specifications for the N5280A Frequency Converter Test Set (10 MHz to 26.5 GHz) are characteristic for the System performance of the PNA and Test Set. Actual performance of the system is based on the customers PNA that is used with the test set. A functional certificate is only offered for the N5280A.

A functional certificate is supplied for the N5280A. The N5280A performance is based on external components such as the calibration kit, network analyzer, external sources, and measurement receiver. There are no internal adjustments in the N5280A, therefore an annual calibration is not required.

Frequency range and connectors are listed in [Table 2](#) for specific ports.

Table 2 Frequency Range and Connectors

Port	Frequency Range	Connectors
RF Port	0.01 to 26.5 GHz	3.5 mm female
LO Port	0.01 to 26.5 GHz	3.5 mm female
IF Port	0.007 to 20 MHz (with jumper, LP OUT) 0.007 to 1.5 GHz (without jumper, Max BW)	SMA female

Power Requirements

Verify that the required ac power is available before installing the Test Set to the PNA.

- Air conditioning equipment (or other motor-operated equipment) should not be placed on the same ac line that powers the Test Set and PNA.
- [Table 3](#) contains the maximum wattage for all instruments. This table can be use to determine the electrical and cooling requirements.

Table 3 Power Requirements

Standard Equipment	
Instrument	Maximum Wattage
N5242A	450
N5264A	450
N5280A	350

WARNING This is a Safety Class I product (provided with a protective earthing ground incorporated in the power cord). The mains plug shall be inserted only into a socket outlet provided with a protective earth contact. Any interruption of the protective conductor, inside or outside the instrument, is likely to make the instrument dangerous. Intentional interruption is prohibited.

Environmental Requirements

The environmental requirements of the test set are listed in [Table 4](#). Note that these requirements are the same as those of the N5242A PNA-X and N5264A Measurement Receiver.

CAUTION Ventilation Requirements: When installing the instrument in a cabinet, the convection into and out of the instrument must not be restricted. The ambient temperature (outside the cabinet) must be less than the maximum operating temperature of the instrument by 4 °C for every 100 watts dissipated in the cabinet. If the total power dissipated in the cabinet is greater than 800 watts, forced convection must be used.

Table 4 PNA Operating Environment

Operating Environmental Requirements:	
Temperature	0 °C to 40 °C (32 °F to 104 °F)
Measurement Calibration	20 °C to 26 °C (68 °F to 79 °F)
Performance Verification	Temperature must be within 1 °C (1.8 °F) of the temperature at which the measurement calibration was performed.
Maximum Relative Humidity	80% for temperatures up to 31 °C decreasing linearly to 50% for a temperature of 40 °C.
Pressure Altitude (Operating)	3000 meters (9,842 feet)
Enclosure Protection	IP 2 0

Environmental Tests

The N5280A complies with all applicable safety and regulatory requirements for the intended location of use and have been evaluated to assure that they are consistent with Agilent quality and reliability goals. On the basis of that evaluation, the following environmental tests have been deemed unnecessary and have not been performed: temperature, humidity, shock, vibration, altitude and power line conditions.

Equipment Heating and Cooling

If necessary, install air conditioning and heating to maintain the ambient temperature within the appropriate range. Air conditioning capacity must be consistent with the BTU ratings given in [Table 3](#).

Required Conditions for Accuracy Enhanced Measurement

Accuracy-enhanced (error-corrected) measurements require the ambient temperature of the PNA and Test Set to be maintained within ± 1 °C of the ambient temperature at calibration.

Dimensions and Space Requirements

Standard installation of the N5280A and PNA includes configuration and installation on a customer provided lab bench, or table top of adequate size and strength.

Table 5 Instrument Dimensions

Model	Weight	Height	Width	Depth
N5242A	37 kg (82 lb, ±0.5 lb)	26.67 cm (10.5 in)	42.5 cm (16.75 in)	55.8 cm (21.97 in)
N5264A	22 kg (48 lb, ±0.5 lb)	26.67 cm (10.5 in)	42.5 cm (16.75 in)	55.8 cm (21.97 in)
N5280A	9.1 kg (20 lb)	8.9 cm (3.5 in)	42.5 cm (16.75 in)	48.3 cm (19 in)

Maximum Power Levels

Table 6 Power Levels

RF Input Power Damage Levels:	
RF Port	+18 dBm
LO Port	+5 dBm
Optimum LO Power	0 dBm (±1 dB)
RF Input @ 0.1 dB Typical Compression:	
A- D Receiver	-10 dBm
IF Output Level¹	
Ports A- D	-10 dBm

1. IF Output level is based on the RF Input @ 0.1 dB typical compression.

NOTE Refer to your PNA specifications to determine the maximum input power levels for the PNA access and test ports, or to optimize the power levels in the receivers.

NOTE Damage and maximum levels are not necessarily the optimum level.

Front and Rear Panel Features

Figure 5 Front Panel

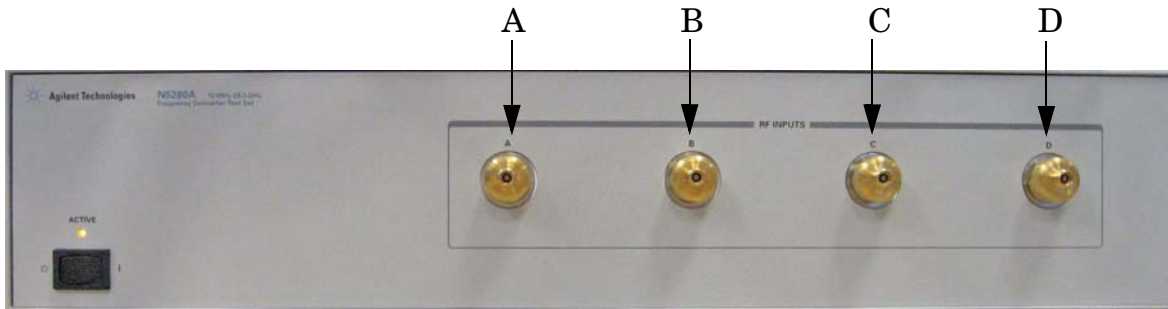

RF Input (A, B, C and D)

These input ports transmit RF energy to the mixer within the instrument.

Line Switch

This switch turns the test set on and off.

- ⏻ – Standby
- | – ON (Active LED On)

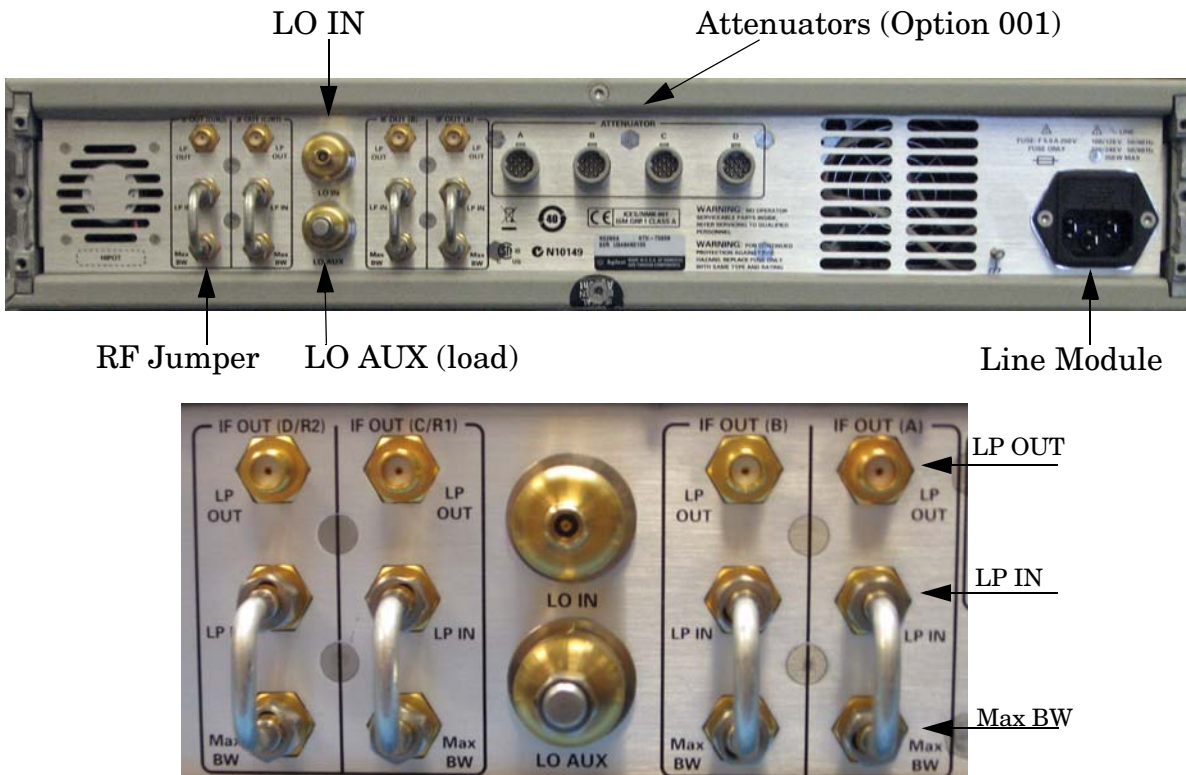
Figure 6 Rear Panel (Multiport Test Set)

IF OUT (A, B, C/R1 and D/R2)

LP OUT from the IF Outputs are connected to the IF Inputs on the PNA-X. The RF Jumper (E8356-20072) is connected between LP IN and Max BW. These connectors transmit the IF signal from the test set to the N5242A 2-Port or 4-Port PNA-X and N5264A Measurement Receiver.

LO IN

LO IN is connected to the LO OUT from the EXT TSET DRIVE on the PNA-X.

LO AUX

The load (1810-0118) is connected to LO AUX.

Attenuators (A, B, C and D)

These connectors are used only in test sets with Option 001. The four Viking attenuator connectors are controlled by the 11713C Attenuator Switch Driver.

Line Module

The line fuse, as well as a spare, reside within the line module. [Figure 7](#) illustrates where the fuses are located and how to access them.

Available Fuses

- Fuse (F 5 A/250V, 2110-0709) UL listed and CSA certified

WARNING For continued protection against fire hazard replace line fuse only with same type and rating: Fuse 5A/250V, Part Number 2110-0709
The use of other fuses or material is prohibited.

Figure 7 Line Fuse



CAUTION This instrument has autoranging line voltage input; be sure the supply voltage is within the specified range.

Controlling the Test Set with N5242A

This section will describe how to setup and operate the N5280A Frequency Converter Test Set with the N5242A 2-Port or 4-Port PNA-X Network Analyzer.

A PNA-X must be used to control the N5280A. The internal LO Source from the PNA-X can be used for testing. Refer to [Figure 8](#) and [Figure 9](#) for cable connections from the N5280A to the N5242A PNA-X.

Figure 8 Front Panel N5280A and N5242A PNA-X

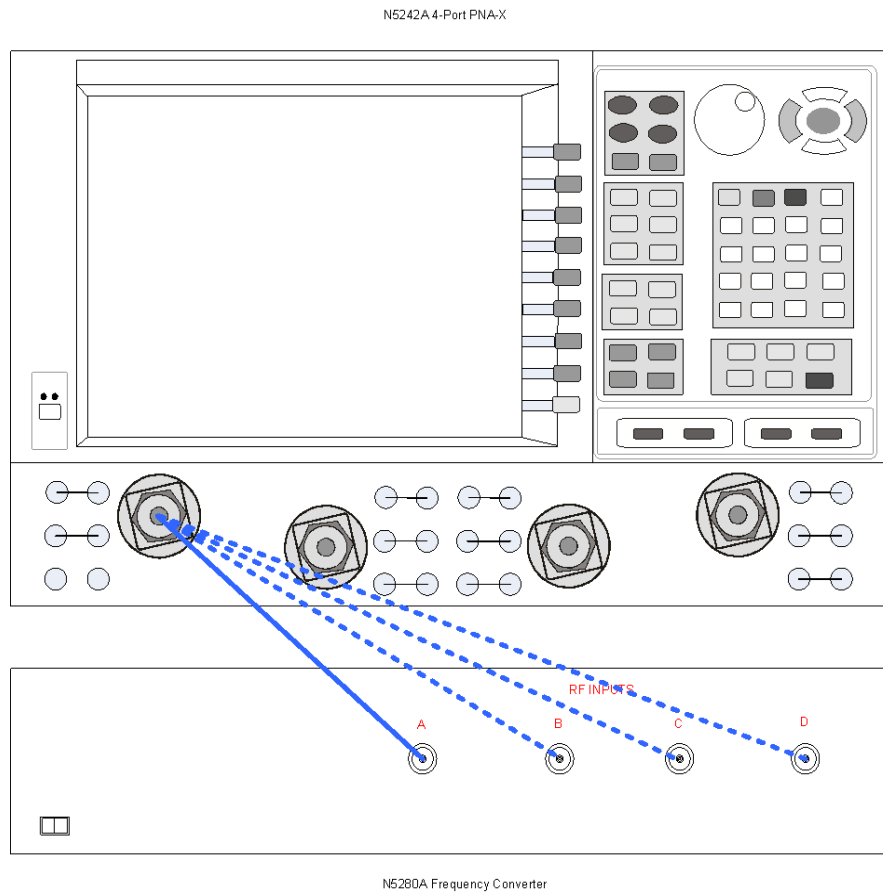
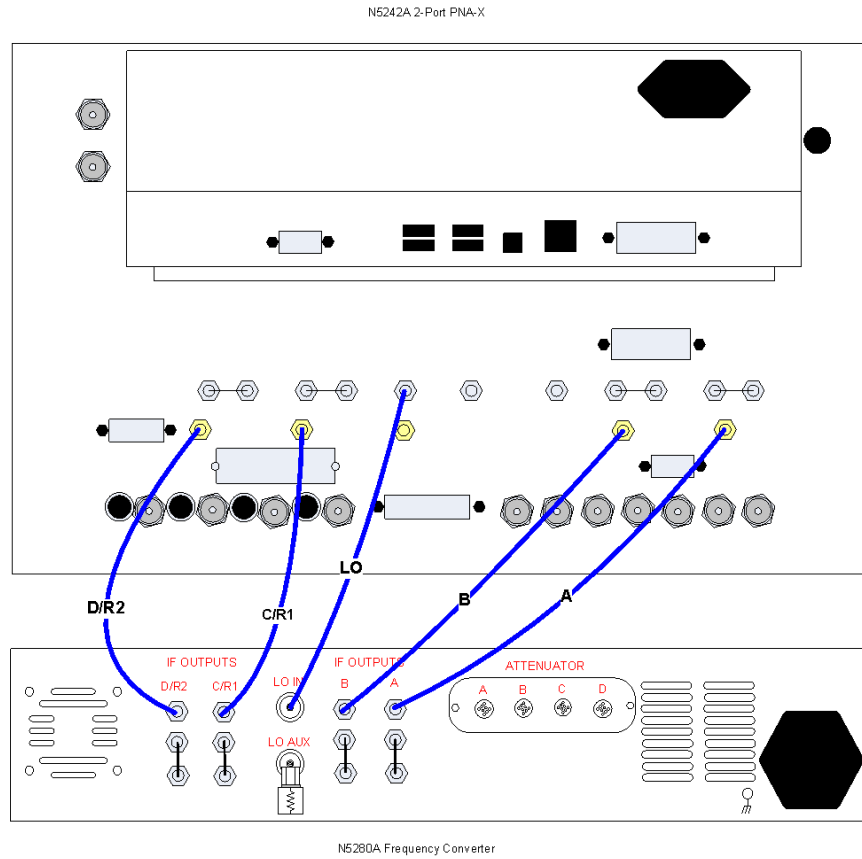

Figure 9 Rear Panel N5280A and N5242A PNA-X



Controlling the Test Set with N5264A

This section will describe how to setup and operate the N5280A Frequency Converter Test Set with the N5264A Measurement Receiver.

A N5264A must be used to control the N5280A. The N5264A Option 108 adds an internal LO Source 26.5 GHz for testing. Refer to [Figure 10](#) and [Figure 11](#) on page 17 for cable connections.

You may also use an external LO Source for testing. Refer to [Figure 12](#) on page 18 and [Figure 13](#) on page 19 for cable connections.

Figure 10 Front Panel N5280A and N5264A with Option 108

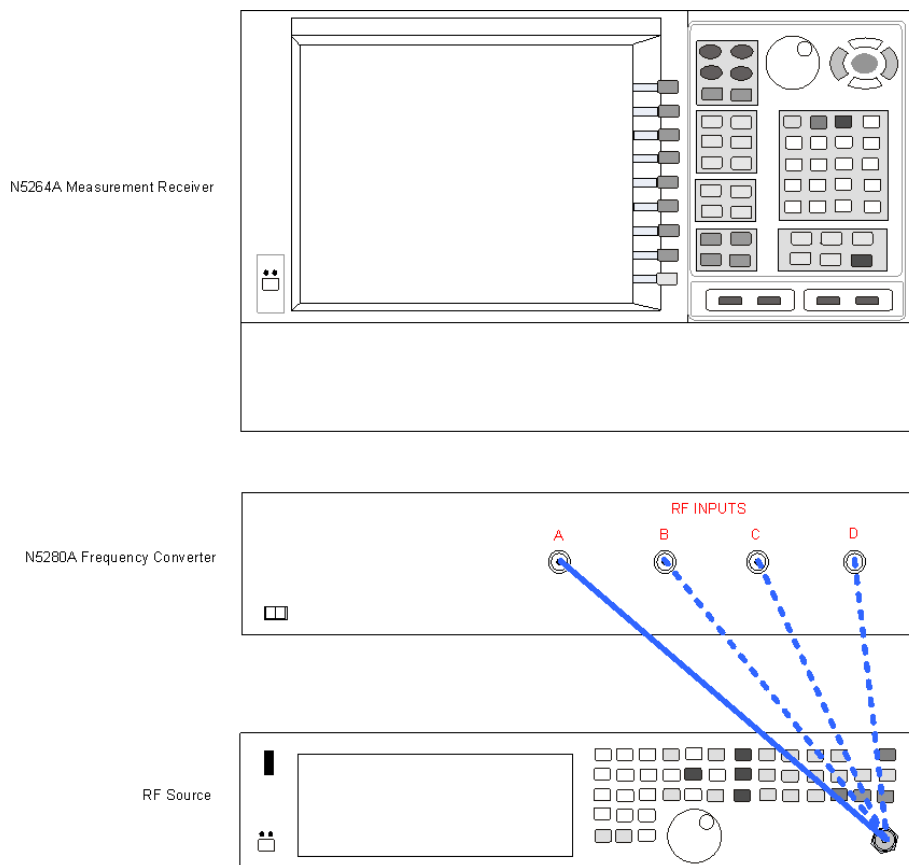

Figure 11 Rear Panel N5280A and N5264A with Option 108

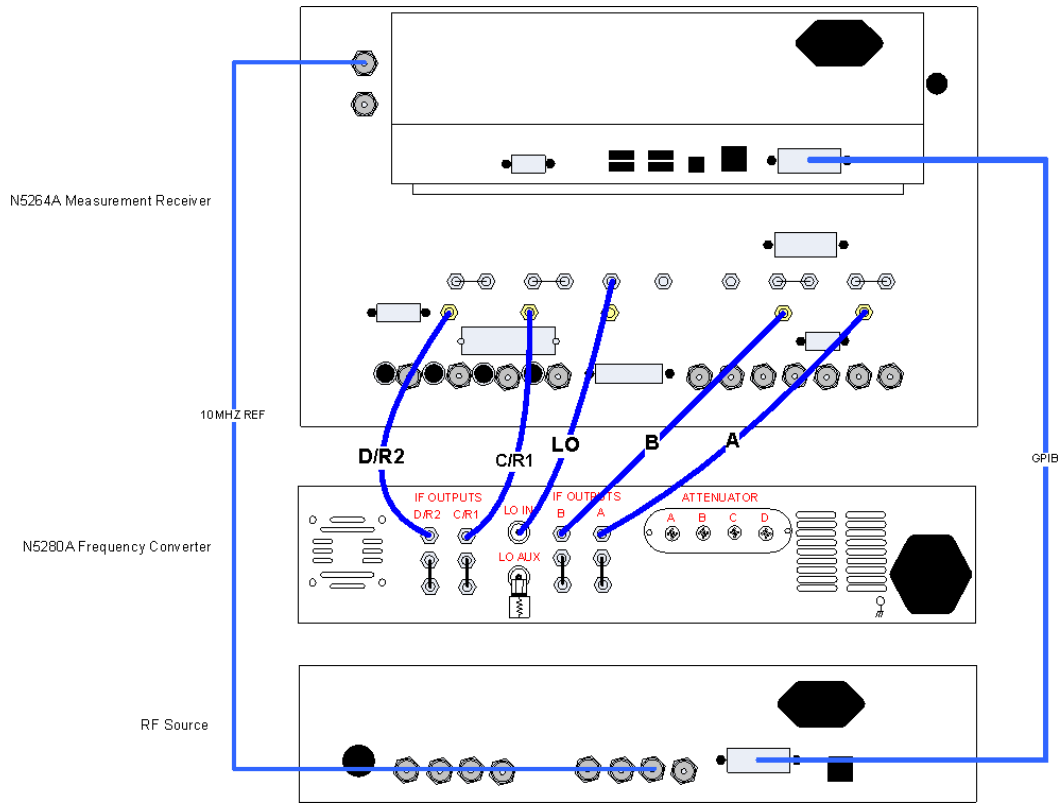

Figure 12 Front Panel N5280A and N5264A without Option 108

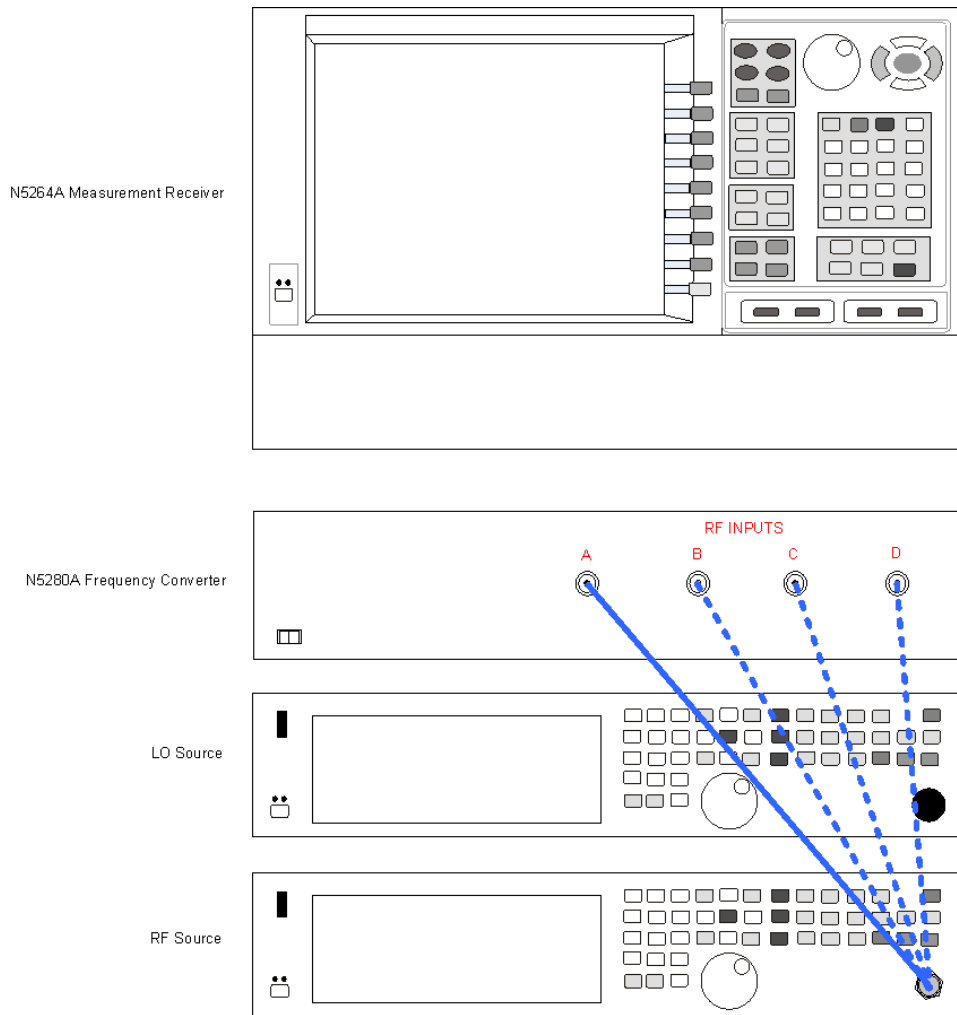
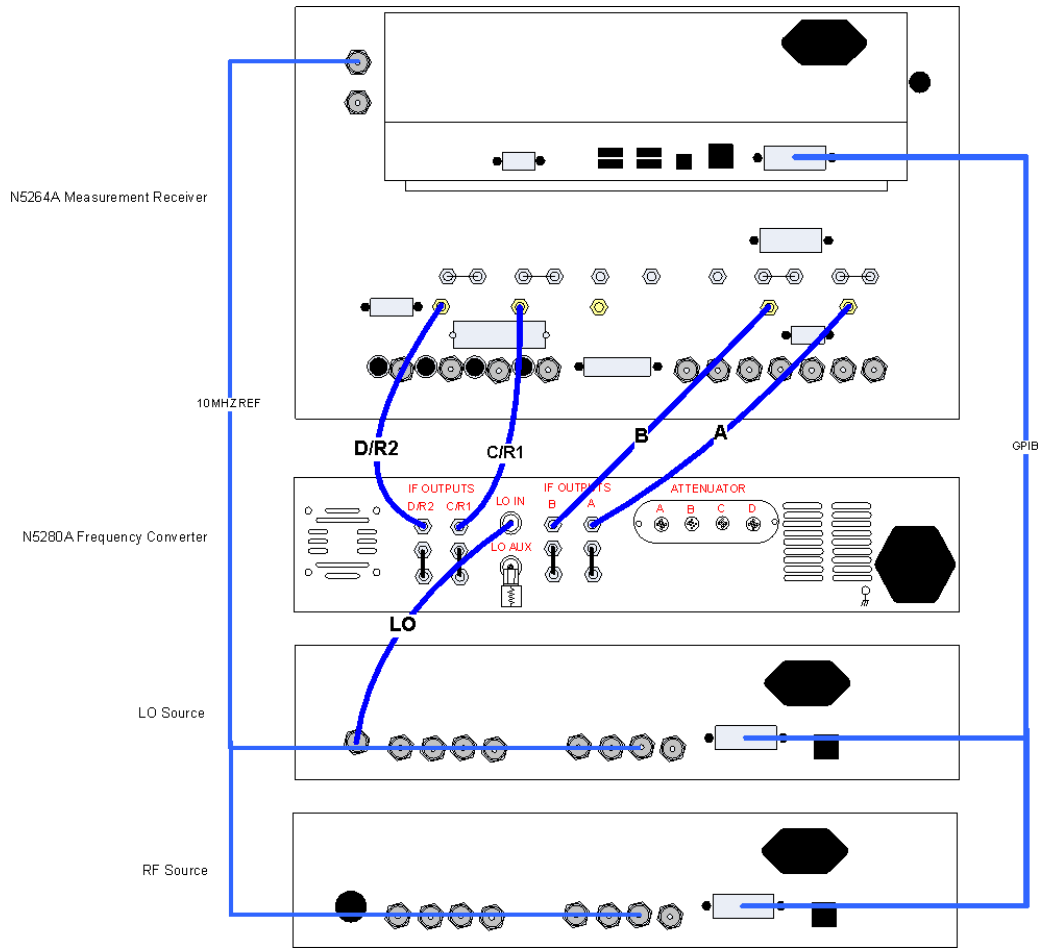

Figure 13 Rear Panel N5280A and N5264A without Option 108



Controlling the RF Receiver Attenuators

The 11713C attenuator switch driver controls the test set through the Viking connector on the rear panel.

Figure 14 Rear Panel N5280A and 11713C

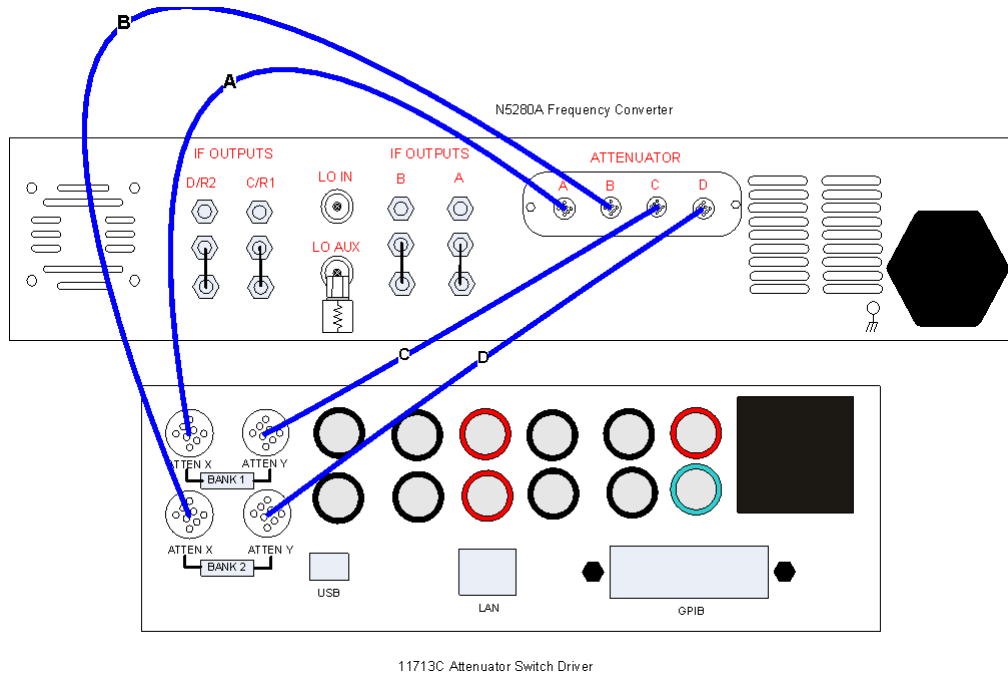

Table 7 illustrates the key combinations that are required to set the attenuation.

Example: In the Attenuator X panel, press 1 & 3 to set A, RF INPUTS to 15 dB.

Table 7 Attenuators

	Attenuator X (A, RF INPUTS)	Attenuator Y (C, RF INPUTS)	Attenuation (dB)
Bank 1	1	5	10
	2	6	20
	3	7	5
	Attenuator X (B, RF INPUTS)	Attenuator Y (D, RF INPUTS)	Attenuation (dB)
Bank 2	1	5	10
	2	6	20
	3	7	5

Figure 15 Front Panel

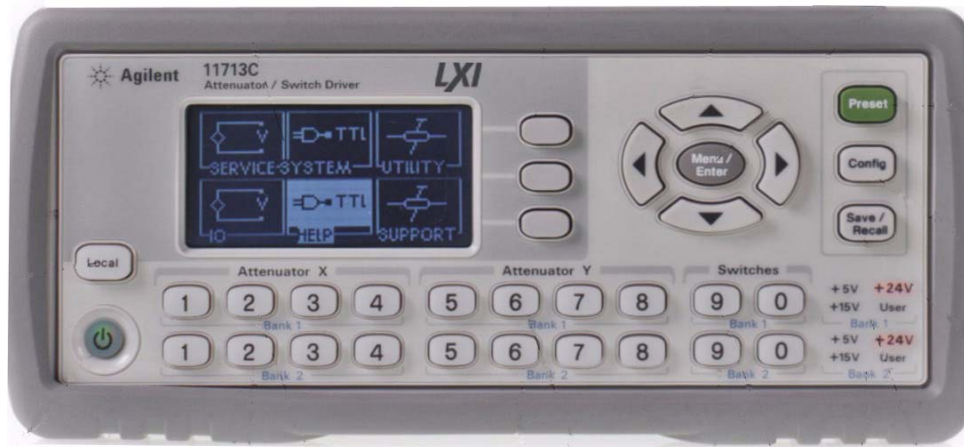

Operational Check

This section provides operational check to confirm the N5280A and PNA-X operational performance. The operation verification limits provided ensure that your N5280A and PNA-X are operating properly.

Equipment Required

The Agilent N5280A requires that the user be familiar with the equipment and components listed in [Table 8](#).

This section provides an equipment list and setup of the PNA-X and Test Set.

Table 8 Equipment List

Description	Qty
N5242A 2-Port or 4-Port PNA-X Network analyzer (Option 020) <i>or</i>	1
N5264A Measurement Receiver (Option 108)	1

Verification Limits

Specifications for the N5280A Multiport Test Set are typical. System performance for the PNA-X and Test Set are only characteristic and intended as non warranted information. Only a functional certificate is provided for the N5280A.

It is recommended that you return your instrument to Agilent Technologies for servicing or repair if the Test Set and PNA-X performance exceed the operational verification limits.

NOTE Typical specifications are based on 1 to 2 units performance.

Table 9 RF Receiver Tracking

RF Port Magnitude Tracking	
Frequency	Value
10 MHz to 20 GHz	±2.0 dB
20 GHz to 22 GHz	±3.0 dB
22 GHz to 26.5 GHz	±4.0 dB

Table 10 Noise Floor

Direct Receiver Access Input Noise Floor¹ IF Bandwidth equal to 10 Hz	
Frequency	Receiver Access Input
10 MHz to 100 MHz	-128 dBm
100 MHz to 500 MHz	-132 dBm
500 MHz to 2 GHz	-133 dBm
2 GHz to 20 GHz	-129 dBm
20 GHz to 24 GHz	-122 dBm
24 GHz to 26.5 GHz	-119 dBm

1. Noise floor measured with a 50 Ohm load at port, and measured as the mean value of a 801 point trace.

Table 11 Trace Noise

Trace Noise Magnitude (dB, rms)¹²³ 1 kHz IF Bandwidth	
Frequency	Typical
10 MHz to 100 MHz	0.02
100 MHz to 13.5 GHz	0.02
13.5 GHz to 16 GHz	0.02
16 GHz to 22.5 GHz	0.04
22.5 GHz to 24 GHz	0.04
24 GHz to 26.5 GHz	0.04
Trace Noise Phase (deg, rms)¹⁴ 1 kHz IF Bandwidth	
10 MHz to 100 MHz	0.15
100 MHz to 13.5 GHz	0.15
13.5 GHz to 16 GHz	0.15
16 GHz to 22.5 GHz	0.25
22.5 GHz to 26.5 GHz	0.25

1. Trace Noise, sweep to sweep variation.
2. Measured linear magnitude CW Frequency at 201 points.
3. Trace Noise in dB = 20 * Log 10 (1+ standard deviation).
4. Trace Noise in degrees = standard deviation.

Table 12 Port Match

RF/LO Port Match	
Frequency	Value
10 MHz to 10 GHz	< -9 dB
10 GHz to 26.5 GHz	< -4 dB

Table 13 Dynamic Range

Dynamic Range @ 10 Hz IF Bandwidth			
Frequency	Typical (dB) Direct Receiver Access Input	Typical (dBm) Low-Level Noise Floor	Typical (dBm) Max Power¹
10 MHz to 50 MHz	120	130	-10
50 MHz to 100 MHz	118	128	-10
100 MHz to 500 MHz	122	132	-10
500 MHz to 2 GHz	123	133	-10
2 GHz to 20 GHz	119	129	-10
20 GHz to 24 GHz	112	122	-10
24 GHz to 26.5 GHz	109	119	-10

1. RCVR IN @ 0.1 dB typical compression at max power.

The receiver access input dynamic range is calculated as the difference between the receiver access input low-level noise floor, and the source maximum power to the receiver that results with a typical 0.1dB compression level.

Low-level noise floor measured with 50 Ohm load at the port.

The effective dynamic range must take measurement uncertainties and interfering signals into account. This set-up should only be used when the receiver input will not exceed its compression or damage level.

Operational Check Procedure

The sequence of this procedure is very important and must be followed or the performance accuracy and results may vary from the reference plots provided.

The following procedures are used with the N5242A 4-Port PNA-X.

NOTE If you are using a N5242A 2-Port PNA-X, channels C and D will be replaced with R1 and R2.

Preparing the N5242A

1. Connect the Test Set to the N5242A 4-Port PNA-X using the cables as shown in [Figure 8 on page 14](#) and [Figure 9 on page 15](#).
2. Connect the 10 dB attenuator to the PNA-X Reference port cable.
3. Turn On the Test Set.
4. Press **[Preset]**.
5. Verify that the Stop Frequency is set to the maximum of the PNA-X and test set. If not, press **[Freq] > Stop**.
6. Verify that the Start Frequency is set to 10 MHz. If not, press **[Freq] > Start > [10 MHz]**.
7. Verify that the Power is to set to -10 dBm. If not, press **[Power] > Power Level** and enter **-10 dBm**.
8. Select **[Avg] > IF Bandwidth > enter 1 kHz**.
9. Select **[Sweep] > Number of Points > enter 401**.
10. Allow the test set and the PNA-X to warm up for a minimum of 30 minutes.
11. Set the IF Switch Config On. **Trace/Chan > Channel > Hardware Setup > IF Switch Config**.

Figure 16 IF Switch Config

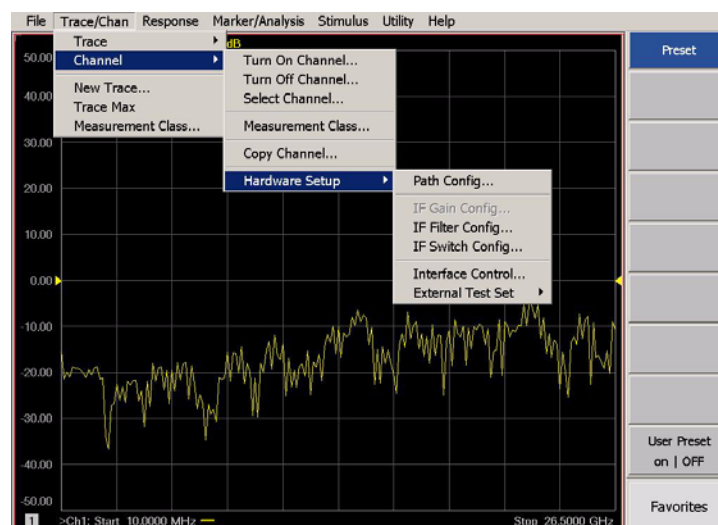

12. Select all of the IF Inputs **External A, B, C and D** > **OK**.

Figure 17 IF Input

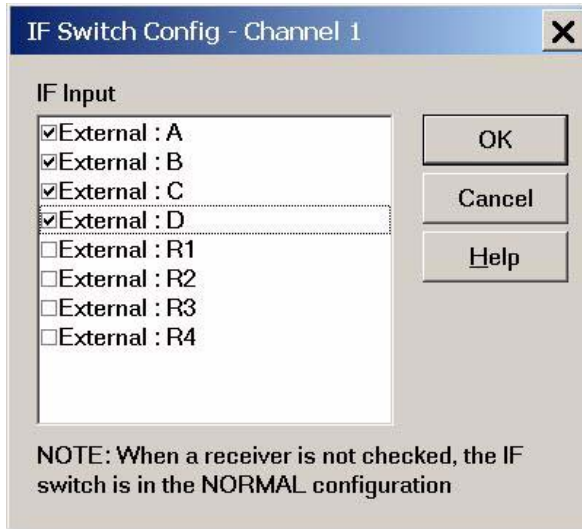

13. Connect the cable to **A, RF INPUTS** on the test set and select **[Meas] > More > Receivers**, select **A > Apply > OK**.

Figure 18 Receiver A

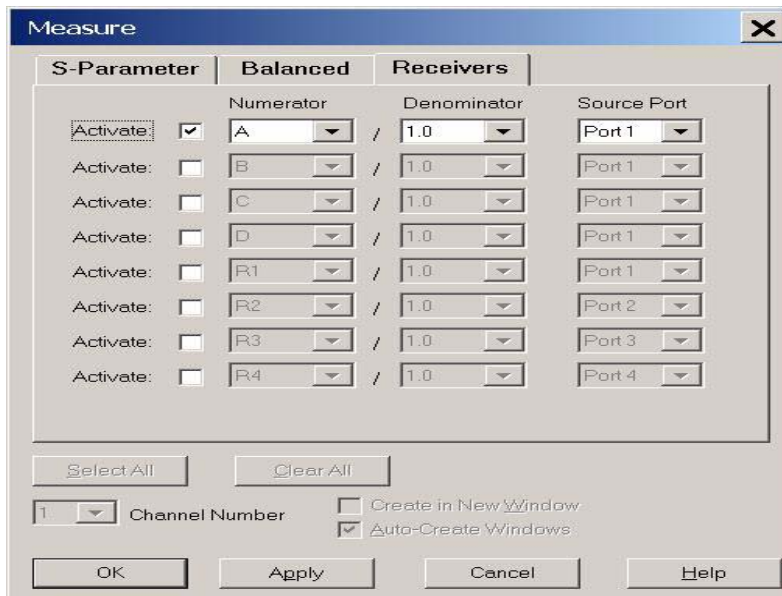

14. Set the Reference level to -20 dBm. Press **[Scale]** > **Reference level** > **$[-20$ dBm]**.

NOTE All of the observed traces should decrease from -17 dB (± 5 dB) at 10 MHz to -34 dB (± 5 dB) at 26.5 GHz. Refer to [Figure 19](#).

Figure 19 Typical Receiver A

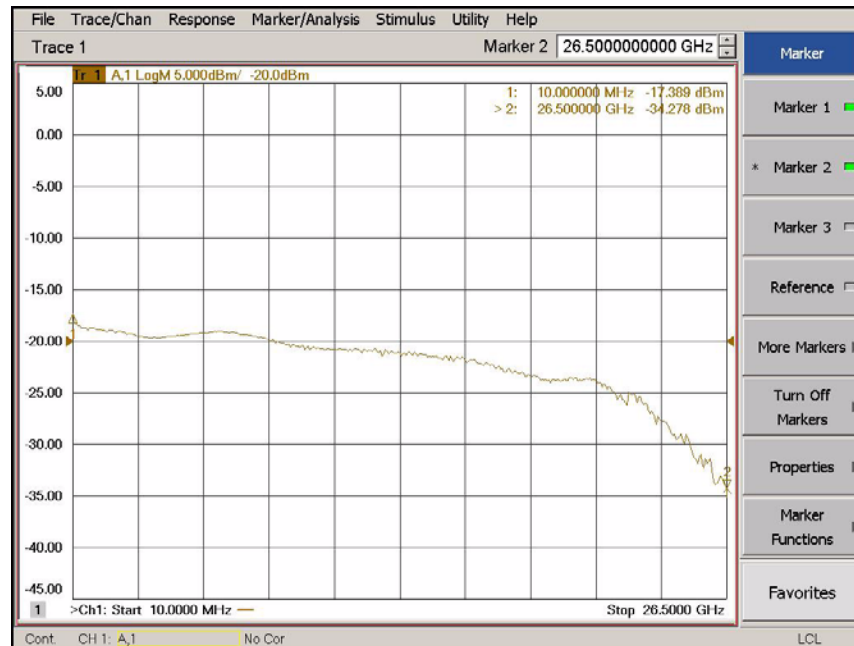

15. Connect the cable to **B, RF INPUTS** on the test set. Select **[Meas]** > **More** > **Receivers**, select **B** > **Apply** > **OK** to observe the power level trace.
16. Connect the cable to **C, RF INPUTS** on the test set. Select **[Meas]** > **More** > **Receivers**, select **C** > **Apply** > **OK** to observe the power level trace.
17. Connect the cable to **D, RF INPUTS** on the test set. Select **[Meas]** > **More** > **Receivers**, select **D** > **Apply** > **OK** to observe the power level trace.

Attenuator Element Verification Procedure

The Attenuator Element Verification Procedure is a functional test only. This test verifies the functionality of the variable attenuator in each channel RF path. The following procedures are used with the 11713C attenuator switch driver.

1. Connect the cables from the test set to the 11713C as shown in [Figure 14 on page 20](#).
2. Press **[Preset]**.
3. Set the IF Switch Config On. Select **Trace/Chan > Channel > Hardware Setup > IF Switch Config**. Refer to [Figure 16 on page 26](#).
4. Select all of the IF Inputs **External A, B, C and D > OK**. Refer to [Figure 17 on page 27](#).
5. Select **[Analysis] > Statistics On**.
6. Select **[Meas] > More > Receivers**, select **A > Apply > OK**. Refer to [Figure 18 on page 27](#).
7. Select **[Memory] > Normalize**.
8. Select **[1]** on the 11713C. The mean value should read -10 dB (± 1 dB). Select **[1]** again, it should read 0 dB.
9. Select **[2]** on the 11713C. The mean value should read -20 dB (± 1 dB). Select **[2]** again, it should read 0 dB.
10. Select **[3]** on the 11713C. The mean value should read -5 dB (± 1 dB). Select **[3]** again, it should read 0 dB.
11. Repeat [step 6](#) through [step 10](#) for **B, C and D RF INPUTS**.

Figure 20 N5280A Block Diagram (Standard 700)

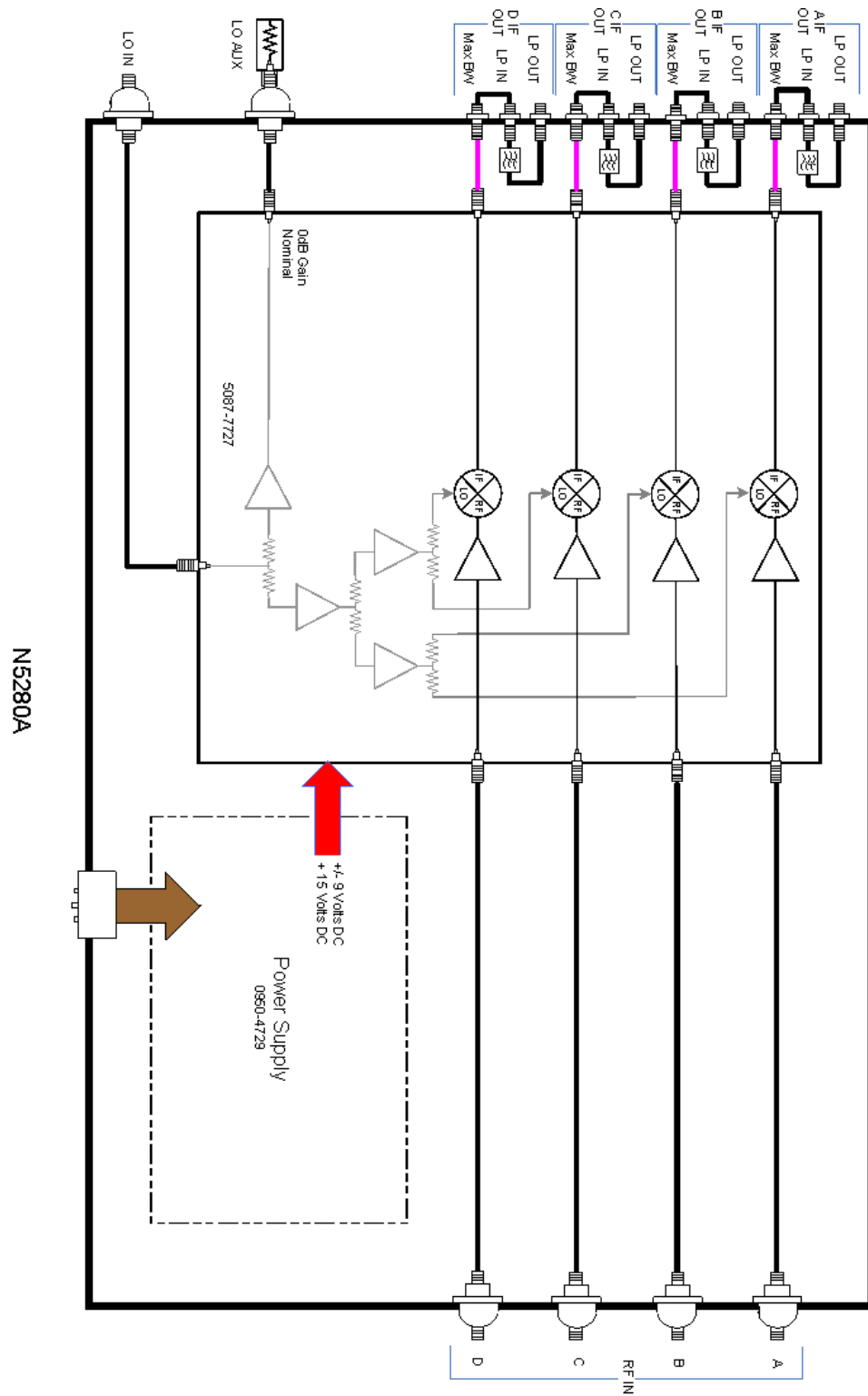
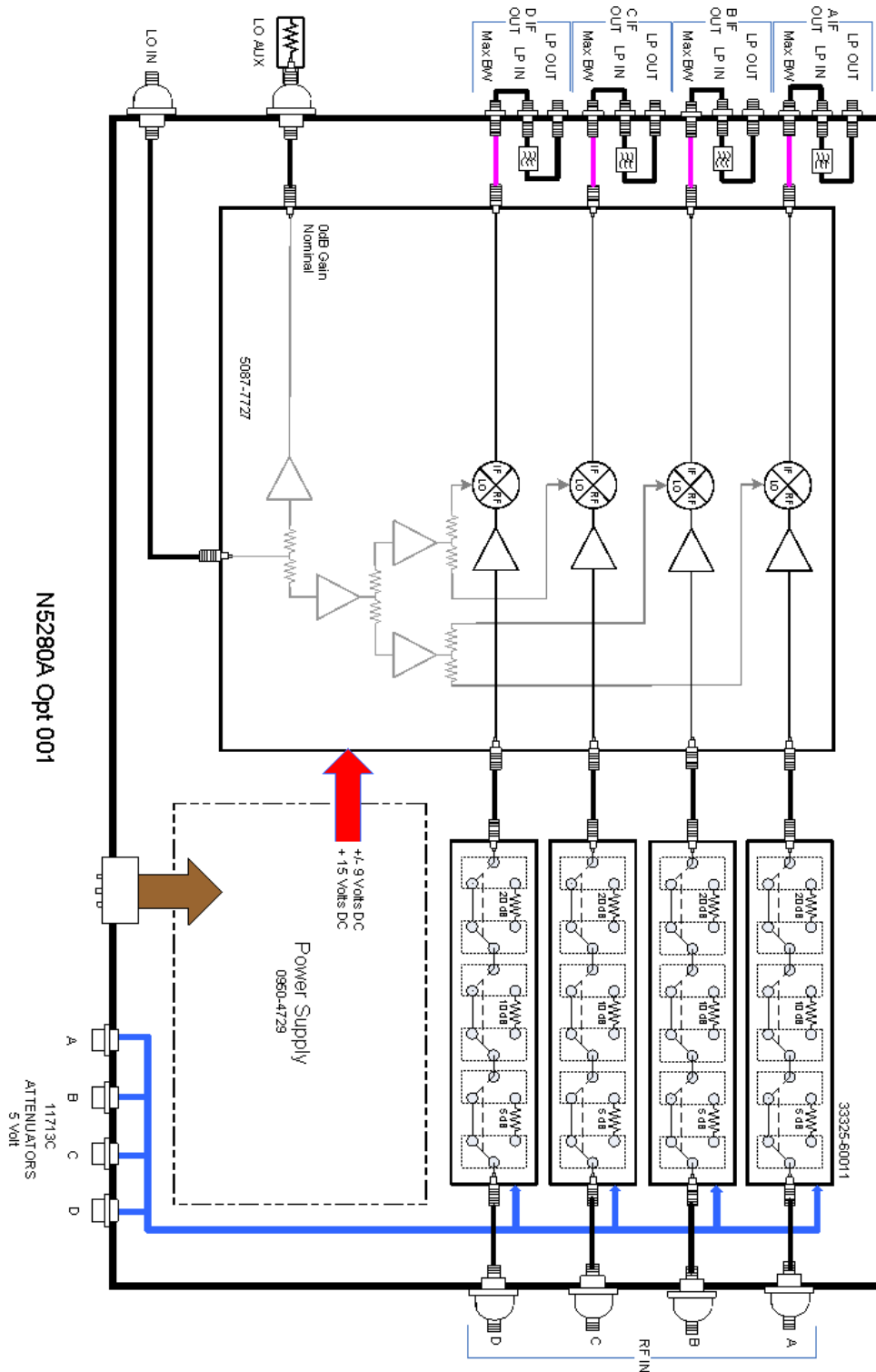

Figure 21 N5280A Block Diagram (Option 001)



Service Information

There are many other repair and calibration options available from the Agilent Technologies support organization. These options cover a range of service agreements with varying response times. Contact Agilent for additional information on available service agreements for this product.

WARNING **No operator serviceable parts inside. Refer servicing to qualified personnel. To prevent electrical shock do not remove covers.**

WARNING **These servicing instructions are for use by qualified personnel only. To avoid electrical shock, do not perform any servicing unless you are qualified to do so.**

Replaceable Parts

Special options are built to order, long lead times may be encountered when ordering replacement parts.

Description		Agilent Part Number
1	PWR Supply (AC/DC SWG 650 W 9-Output)	0950-4729
2	Fuse (8 A 250 V non-time delay 0.0146 Ohm)	2110-0342
3	Mixer Brick Bias Board Assembly	N5280-63015
4	Mixer Brick 26.5 GHz Assembly	5087-7727
5	3.5 mm Bulkhead Connector (female)	5062-6618
6	RF Cable, semi-rigid (LPF)	N5280-20017
7	RF Cable, semi-rigid (MXB to LO IN)	N5280-20005
8	RF Cable, semi-rigid (MXB to LO AUX)	N5280-20006
N5280A Option 700 (Standard):		
9	RF Cable, semi-rigid (MXB to A)	N5280-20001
10	RF Cable, semi-rigid (MXB to B)	N5280-20002
11	RF Cable, semi-rigid (MXB to C)	N5280-20003
12	RF Cable, semi-rigid (MXB to D)	N5280-20004
N5280A Option 001:		
13	Attenuator (35 dB) 50 GHz, 3-Section Y-Contact, 5 V, 2.4 mm Connector	33325-60011
14	RF Cable, semi-rigid (ATTN-A to MXB)	N5280-20007
15	RF Cable, semi-rigid (ATTN-A to A)	N5280-20008

Description		Agilent Part Number
16	RF Cable, semi-rigid (ATTN-B to MXB)	N5280-20009
17	RF Cable, semi-rigid (ATTN-B to B)	N5280-20010
18	RF Cable, semi-rigid (ATTN-C to MXB)	N5280-20011
19	RF Cable, semi-rigid (ATTN-C to C)	N5280-20012
20	RF Cable, semi-rigid (ATTN-D to MXB)	N5280-20013
21	RF Cable, semi-rigid (ATTN-D to D)	N5280-20014

Figure 22 N5280A Option 700 (Standard)

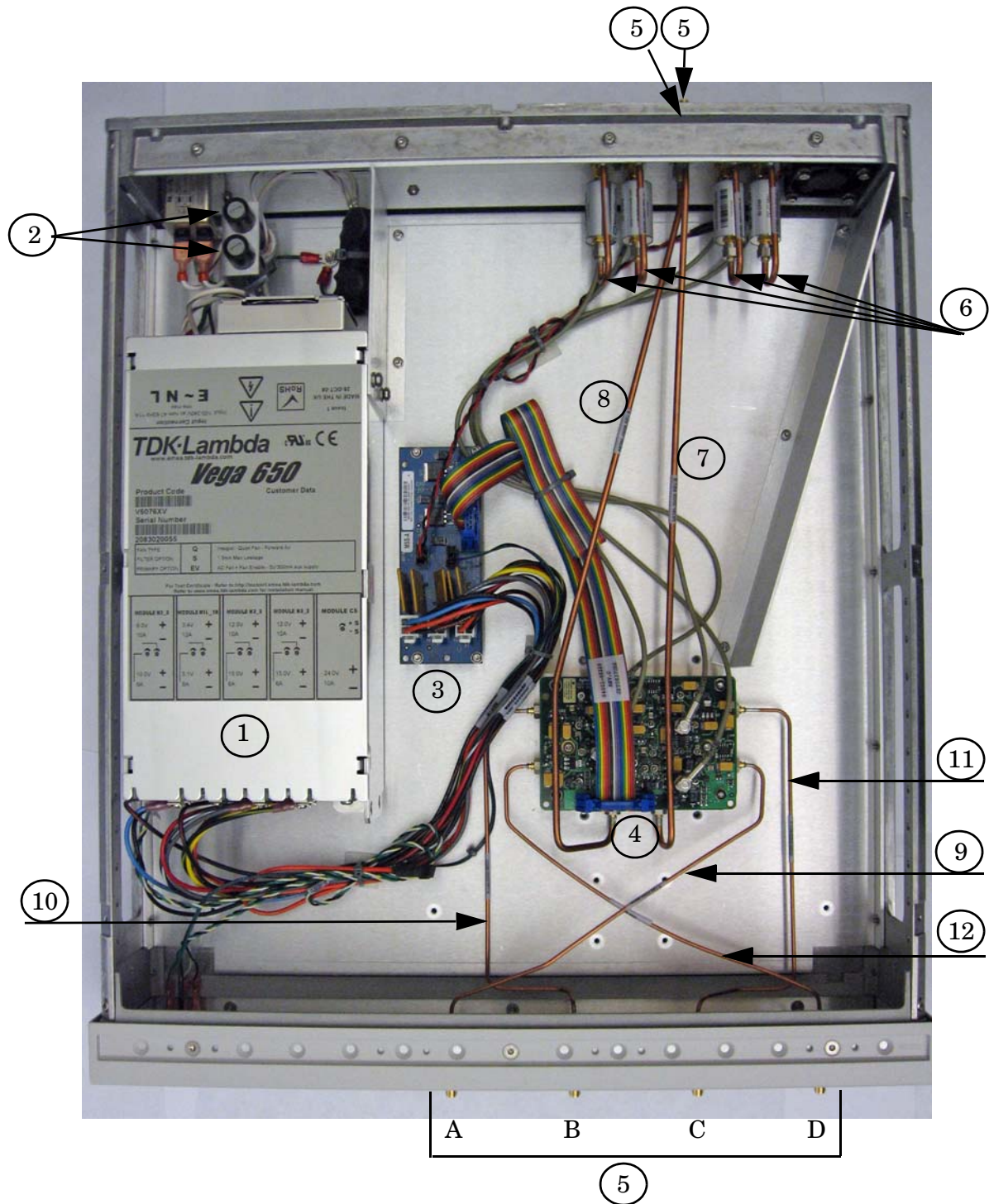
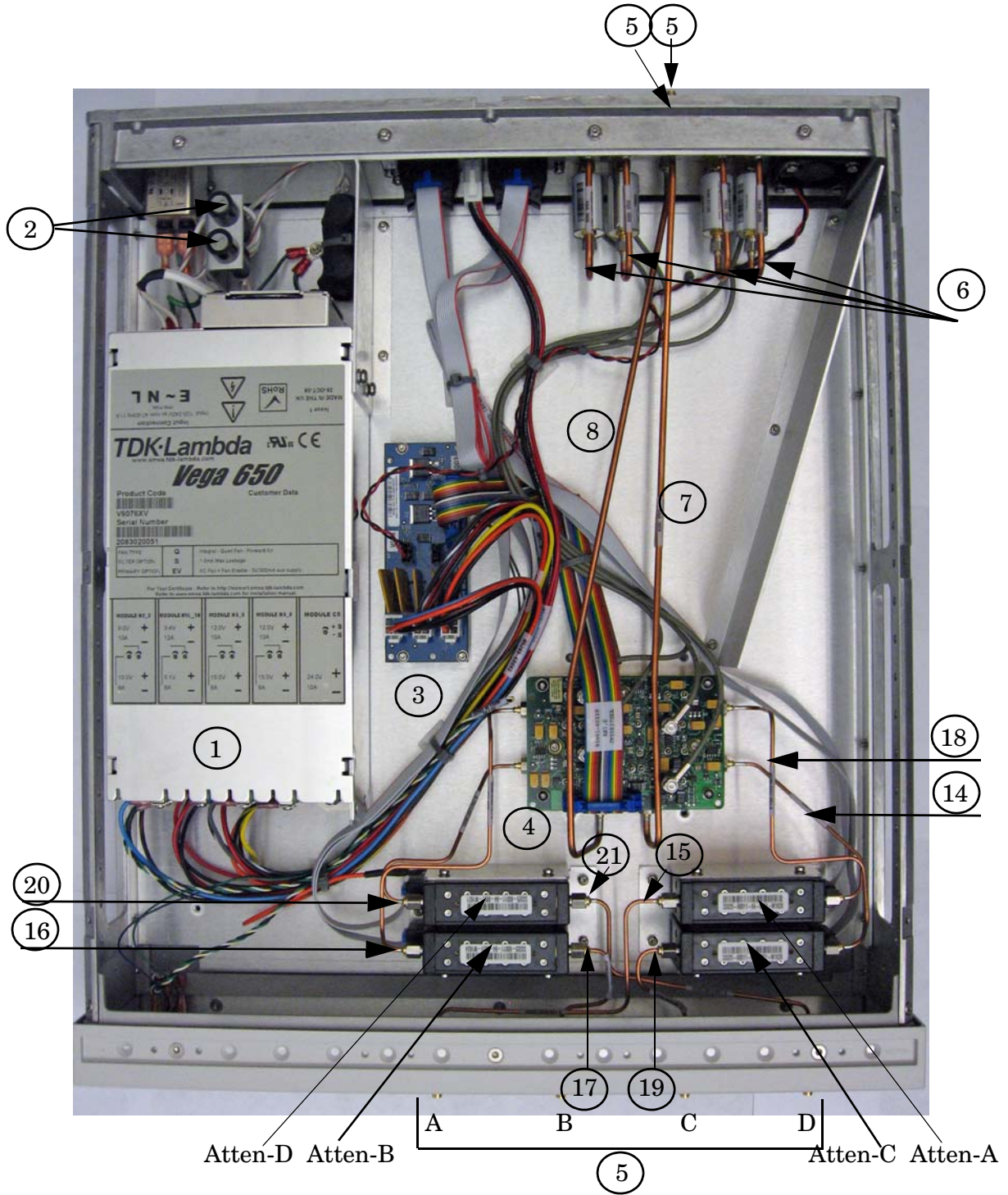

Figure 23 N5280A Option 001



Safety and Regulatory Information

Introduction

Review this product and related documentation to familiarize yourself with safety markings and instructions before you operate the instrument. The documentation contains information and warnings that must be followed by the user to ensure safe operation and to maintain the product in a safe condition.

Before Applying Power

Verify that the premises electrical supply is within the range of the instrument. The instrument has an autoranging power supply.

WARNING To prevent electrical shock, disconnect the [Agilent Technologies N5280A](#) from mains power supply before cleaning. Use a dry cloth or one slightly dampened with water to clean the external case parts. Do not attempt to clean internally.

Connector Care and Cleaning

If alcohol is used to clean the connectors, the power cord to the instrument must be removed. All cleaning should take place in a well ventilated area. Allow adequate time for the fumes to disperse and moist alcohol to evaporate prior to energizing the instrument.

WARNING Keep isopropyl alcohol away from heat, sparks, and flame. Store in a tightly closed container. It is extremely flammable. In case of fire, use alcohol foam, dry chemical, or carbon dioxide; water may be ineffective.

Declaration of Conformity

A declaration of conformity is on file for the PNA models, and a copy is available upon request, or a copy is available on the Agilent Technologies web site at <http://regulations.corporate.agilent.com/DoC/search.htm>

Shipping Your Analyzer to Agilent for Service or Repair

The N5280A instrument is to be returned to factory for service or repair.

You must always call the Agilent Technologies Instrument Support Center to initiate service before retuning your instrument to a service office. See [“Contacting Agilent Sales and Service Offices” on page 42](#). Always transport or ship the instrument using the original packaging if possible. If not, comparable packaging must be used. Attach a complete description of the failure symptoms.

Compliance with German Noise Requirements

This is to declare that this instrument is in conformance with the German Regulation on Noise Declaration for Machines (Laermangabe nach der Maschinenlaermverordnung-3. GSGV Deutschland).

Acoustic Noise Emission/Geraeuschemission	
LpA<70 dB	Lpa<70 dB
Operator Position	am Arbeitsplatz
Normal Operation	normaler Betrieb
per ISO 7779	nach DIN 45635 t. 19

EMC Information

Complies with European EMC Directive 2004/108/EC

- IEC/EN 61326-1
- CISPR Pub 11 Group 1, class A
- AS/NZS CISPR 11
- This ISM device complies with Canadian ICES-001.
Cet appareil ISM est conforme a la norme NMB du Canada.

Safety Information

Complies with European Low Voltage Directive 2006/95/EC

- IEC/EN 61010-1, 2nd edition
- Canada: CSA C22.2 No. 61010-1-04
- USA: UL Std. No. 61010-1 (2nd Edition)

Warnings

WARNING The **WARNING** notice denotes a hazard. It calls attention to a procedure, practice, or the like, which if not correctly performed or adhered to, could result in personal injury. Do not proceed beyond a **WARNING** notice until the indicated conditions are fully understood and met.

Warnings applicable to this instrument are:

WARNING For continued protection against fire hazard replace line fuse only with same type and rating: Fuse 5A/250V, Part Number 2110-0709
The use of other fuses or material is prohibited.

WARNING This is a Safety Class I product (provided with a protective earthing ground incorporated in the power cord). The mains plug shall be inserted only into a socket outlet provided with a protective earth contact. Any interruption of the protective conductor, inside or outside the instrument, is likely to make the instrument dangerous. Intentional interruption is prohibited.

WARNING No operator serviceable parts inside. Refer servicing to qualified personnel. To prevent electrical shock do not remove covers.

WARNING The opening of covers or removal of parts is likely to expose the user to dangerous voltages. Disconnect the instrument from all voltage sources while it is being opened.

WARNING If this product is not used as specified, the protection provided by the equipment could be impaired. This product must be used in a normal condition (in which all means for protection are intact) only.

WARNING The detachable power cord is the instrument disconnecting device. It disconnects the mains circuits from the mains supply before other parts of the instrument. The front panel switch is only a standby switch and is not a LINE switch (disconnecting device).

Cautions

CAUTION The CAUTION notice denotes a hazard. It calls attention to an operating procedure, practice, or the like, which if not correctly performed or adhered to, could result in damage to the product or loss of important data. Do not proceed beyond a CAUTION notice until the indicated conditions are fully understood and met.

Cautions applicable to this instrument are:

CAUTION Always use the three-prong ac power cord supplied with this instrument. Failure to ensure adequate earth grounding (by not using this cord) can cause instrument damage and the risk of electrical shock.

CAUTION This instrument has autoranging line voltage input; be sure the supply voltage is within the specified range.

CAUTION Ventilation Requirements: When installing the instrument in a cabinet, the convection into and out of the instrument must not be restricted. The ambient temperature (outside the cabinet) must be less than the maximum operating temperature of the instrument by 4 °C for every 100 watts dissipated in the cabinet. If the total power dissipated in the cabinet is greater than 800 watts, forced convection must be used.

CAUTION This product is designed for use in Installation Category II and Pollution Degree 2.

Instrument Markings



The instruction documentation symbol. The product is marked with this symbol when it is necessary for the user to refer to the instructions in the documentation.



This symbol indicates that the instrument requires alternating current (ac) input.



This symbol indicates separate collection for electrical and electronic equipment, mandated under EU law as of August 13, 2005. All electric and electronic equipment are required to be separated from normal waste for disposal (Reference WEEE Directive, 2002/96/EC).



This symbol indicates that the power line switch is ON.



This symbol indicates that the power line switch is in the STANDBY position.



This symbol indicates that the power line switch is in the OFF position.



This symbol is used to identify a terminal which is internally connected to the product frame or chassis.



The CE mark is a registered trademark of the European Community. (If accompanied by a year, it is when the design was proven.)



The CSA mark is a registered trademark of the CSA International. This instrument complies with Canada: CSA 22.2 No. 61010-1-04.



This is a symbol of an Industrial Scientific and Medical Group 1 Class A product.



This is a marking to indicate product compliance with the Canadian Interference-Causing Equipment Standard (ICES-001).



Direct Current.



This is a required mark signifying compliance with an EMC requirement. The C-Tick mark is a registered trademark of the Australian Spectrum Management Agency.



China RoHS regulations include requirements related to packaging, and require compliance to China standard GB18455-2001.



This symbol indicates compliance with the China RoHS regulations for paper/fiberboard packaging.

Electrostatic Discharge Protection

Protection against electrostatic discharge (ESD) is essential while removing assemblies from or connecting cables to the network analyzer. Static electricity can build up on your body and can easily damage sensitive internal circuit elements when discharged. Static discharges too small to be felt can cause permanent damage. To prevent damage to the instrument:

- *always* have a grounded, conductive table mat (9300-0797) in front of your test equipment.
- *always* wear a grounded wrist strap (9300-1367) with grounding cord (9300-0980), connected to a grounded conductive table mat, having a 1 M Ω resistor in series with it, when handling components and assemblies or when making connections.
- *always* wear a heel strap (9300-1126) when working in an area with a conductive floor. If you are uncertain about the conductivity of your floor, wear a heel strap.
- *always* ground yourself before you clean, inspect, or make a connection to a static-sensitive device or test port. You can, for example, grasp the grounded outer shell of the test port or cable connector briefly.
- *always* ground the center conductor of a test cable before making a connection to the analyzer test port or other static-sensitive device. This can be done as follows:
 1. Connect a short (from your calibration kit) to one end of the cable to short the center conductor to the outer conductor.
 2. While wearing a grounded wrist strap, grasp the outer shell of the cable connector.
 3. Connect the other end of the cable to the test port and remove the short from the cable.

Figure 14 ESD Protection Setup

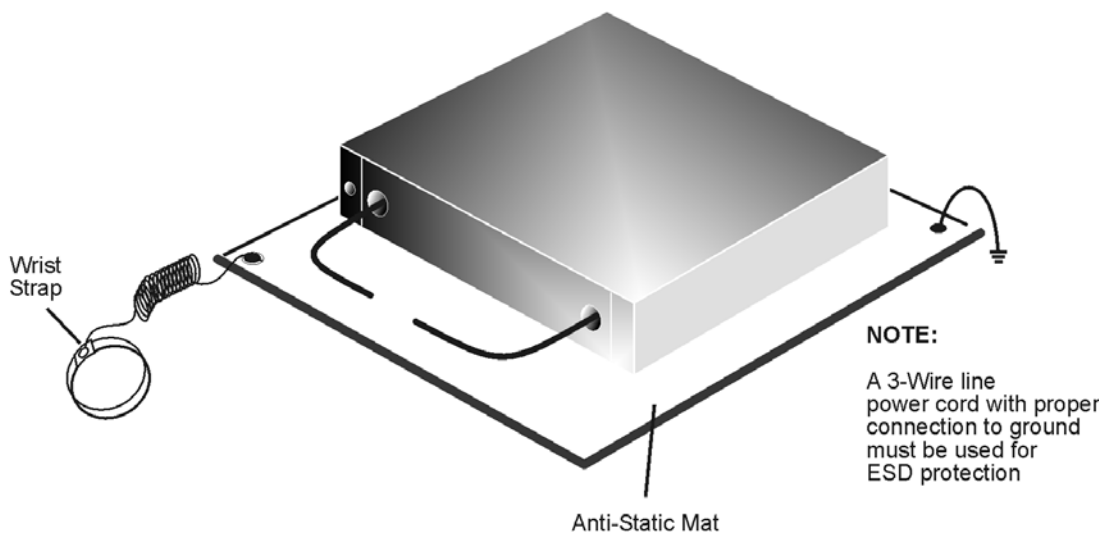

ku310b

Contacting Agilent Sales and Service Offices

Assistance with test and measurement needs, and information on finding a local Agilent office are available on the Internet at:

<http://www.agilent.com/find/assist>

You can also purchase accessories or documentation items on the Internet at:

<http://www.agilent.com/find>

If you do not have access to the Internet, contact your field engineer.

NOTE In any correspondence or telephone conversation, refer to the product by its model number and full serial number. With this information, the Agilent representative can determine the warranty status of your unit.
