

Agilent P940xA/C Solid State PIN Diode Switches

P9402A 100 MHz to 8 GHz SPDT PIN switch
P9402C 100 MHz to 18 GHz SPDT PIN switch
P9404A 100 MHz to 8 GHz SP4T PIN switch
P9404C 100 MHz to 18 GHz SP4T PIN switch

Technical Overview

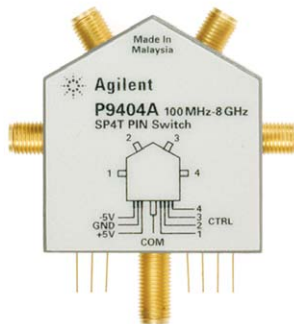

Key Features

- Dramatically increase throughput with ultra fast switching speed of < 450 ns
- Reduce test system set up costs with the long switching life
- Minimize cross-talk with exceptionally high port-to-port isolation of > 80 dB
- Optimize your system dynamic range with low insertion loss switches, 2.5 dB at 4 GHz, SP4T



Agilent Technologies

Description

Agilent P940xA/C absorptive solid state switches, based on PIN diode technology, provide superior performance in terms of isolation, insertion loss and return loss across a broad operating frequency range. The P940xA/C are particularly suitable for high-speed RF and microwave switching applications in instrumentation, communication, radar, switch matrices as well as many other test systems.

The P9402A/C switches have a SPDT PIN diode individual control switch IC and discrete shunt pin diodes on the RF path. The discrete shunt pin diodes enhance the isolation between ports. The switch's individual control pin controls the port between the ON and OFF state. With these features, the switch provides good port match even when it is off. Hence, this SPDT switch has three switching states, switching between the common port and port 1 or port 2 or all ports Off.

The P9404A/C switches have a SP4T PIN diode switch IC and discrete shunt pin diodes on the RF path. The P9404A/C SP4T switches have five switching states, switching between the common port to any one of the 4 output ports or, all ports to the OFF state (terminated at 50 Ohm).

Application

Solid state switches can be used in a large number of applications, increasing system flexibility and simplifying system design. They are preferred in test systems where speed is critical.

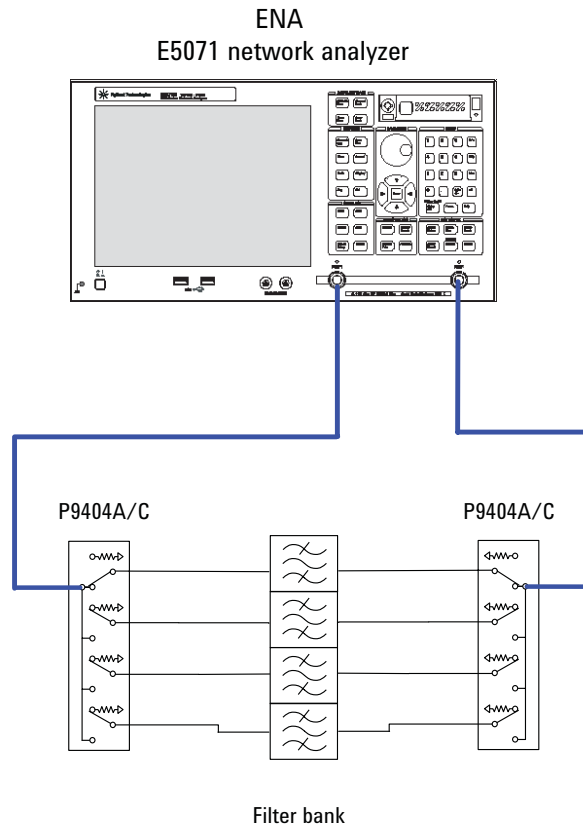

Figure 1. Filter bank test setup

The figure above shows a typical test setup for filter bank testing. Two SP4T absorptive PIN switches are needed for the S parameter measurement with ENA. Mobile handset and semiconductor manufacturers use PIN switches because fast switching speeds are needed for high volume testing of filters e.g. SAW filters. P940xA/C are particularly suitable for the application due to two reasons; the low insertion loss optimizes the dynamic range, and TTL control enables the switches to be controlled easily, using +5V or 0V.

Specifications

Specifications refer to the performance standards or limits against which the solid state switches are tested.

Typical characteristics are included for additional information only and they are not specifications. These are denoted as “typical”, “nominal” or “approximate” and are printed in italic.

RF Specifications

SPDT

Model	P9402A	P9402C
Frequency range	100 MHz to 8 GHz	100 MHz to 18 GHz
Insertion loss	< 2.5 dB (100 MHz to 4 GHz)	< 3.5 dB (100 MHz to 8 GHz)
	< 3.2 dB (4 GHz to 8 GHz)	< 4 dB (8 GHz to 18 GHz)
Isolation	80 dB	80 dB
Return loss (ON & Common Port)	> 15 dB	> 10 dB
Return loss (OFF Port)	> 15 dB	> 10 dB
Switching speed rise/fall ¹	380 ns (typical)	380 ns (typical)
Characteristic impedance	50 Ω (nominal)	50 Ω (nominal)
Connectors	SMA (f)	SMA (f)

1. Switching speed is based on 50% TTL to 90% RF.

SP4T

Model	P9404A	P9404C
Frequency range	100 MHz to 8 GHz	100 MHz to 18 GHz
Insertion loss	< 2.5 dB (100 MHz to 4 GHz)	< 3.5 dB (100 MHz to 8 GHz)
	< 3.5 dB (4 GHz to 8 GHz)	< 4.5 dB (8 GHz to 18 GHz)
Isolation	80 dB	80 dB
Return loss (ON & Common Port)	> 15 dB	> 10 dB
Return loss (OFF Port)	> 15 dB	> 10 dB
Switching speed rise/fall ¹	450 ns (typical)	450 ns (typical)
Characteristic impedance	50 Ω (nominal)	50 Ω (nominal)
Connectors	SMA (f)	SMA (f)

1. Switching speed is based on 50% TTL to 90% RF.

Absolute maximum ratings

Parameters	P9402A/C		P9404A/C	
	MIN	MAX	MIN	MAX
RF input power (average)		+23 dBm		+27 dBm
V _{CC} DC Supply Voltage	+4.5 V	+5.5 V	+4.5 V	+5.5 V
V _{EE} DC Supply Voltage	-5.5 V	-4.5 V	-5.5 V	-4.5 V
CTRL input high voltage	+2.4 V	V _{CC}	+2.4 V	V _{CC}
CTRL input low voltage	-0.8 V	+0.8 V	-0.8 V	+0.8 V

Environmental Specifications

The P940xA/C PIN diode switches are designed to fully comply with Agilent Technologies' product operating environment specifications. The following summarizes the environmental specifications for these products.

Temperature

Operating -55 °C to +95 °C

Storage -65 °C to +125 °C

Cycling -65 °C to +150 °C, 10 cycles @ 20 °C per minute, 20 minutes dwell time per MIL-STD-833F, Method 1010.8, Condition C (modified)

Humidity

Operating 50% to 95% RH @ 40 °C, one 24 hour cycle, repeated 5 times

Storage < 90% RH @ 65 °C for 24 hours

Shock

Half-sine, 1000 G @ 0.5 ms, 3 shock pulses per orientation, 18 total smoothed per MIL-STD-833F, Method 2002.4, Condition B (modified)

Vibration

Broadband, 50 to 2000 Hz, 7.0 G rms, 15 minutes, per MIL-STD-833F, random Method 2026-1 (modified)

Altitude

Storage < 15,300 meters (50,000 feet)

ESD immunity

Direct discharge 2.5 kV per IEC 61000-4-2

Air discharge 3.5 kV per IEC 61000-4-2

Mechanical Dimensions

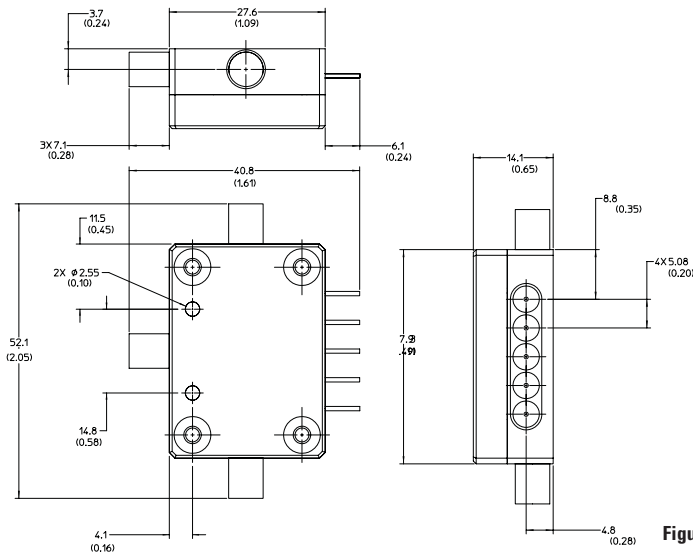

Figure 2. Product dimensions for P9402A/C

Dimensions in millimeters and inches.

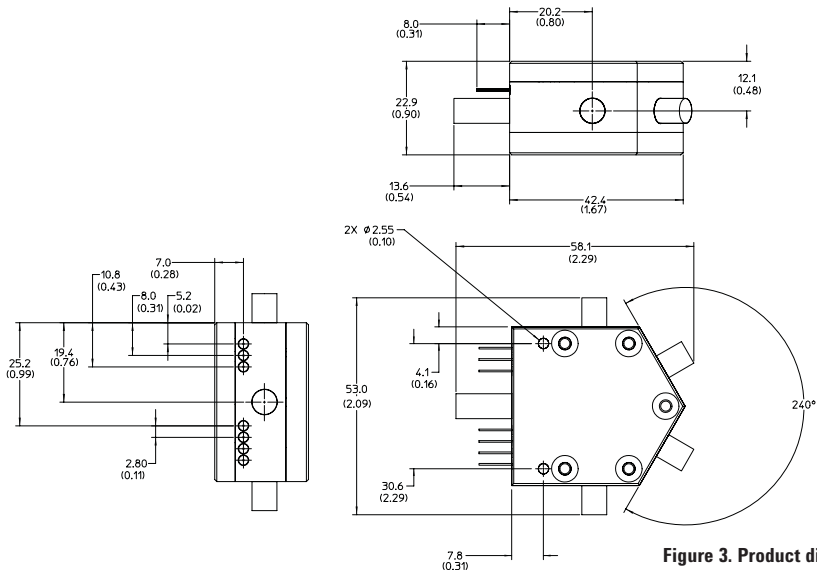

Figure 3. Product dimensions for P9404A/C

Model	Weight
P9402A/C	50 g
P9404A/C	105 g

Typical performance

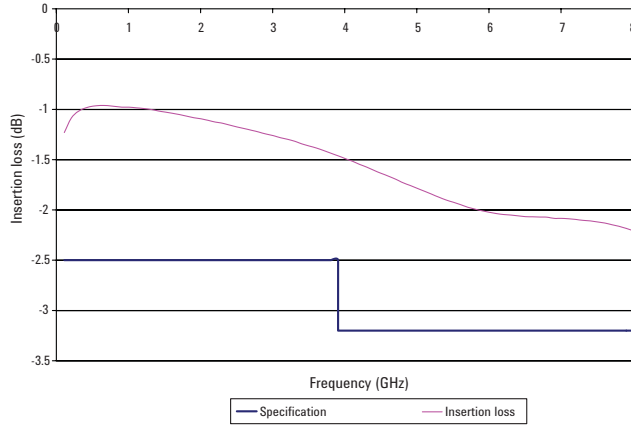

Figure 4. P9402A insertion loss vs. frequency (typical)

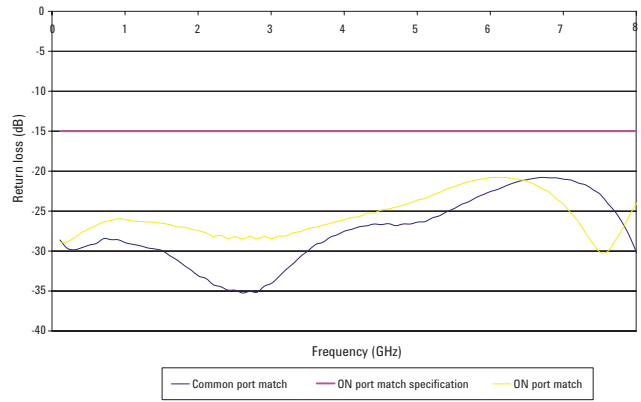

Figure 5. P9402A return loss (ON) vs. frequency (typical)

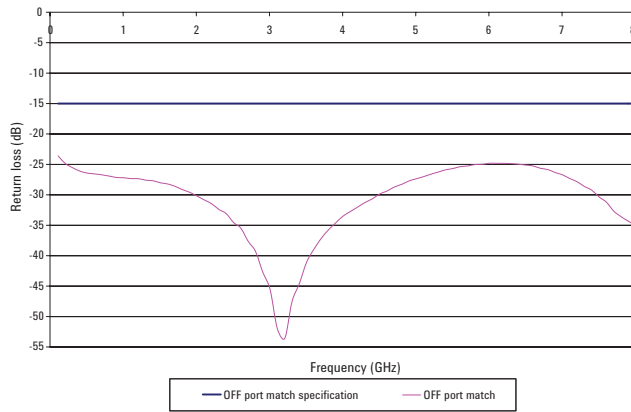

Figure 6. P9402A return loss (OFF) vs. frequency (typical)

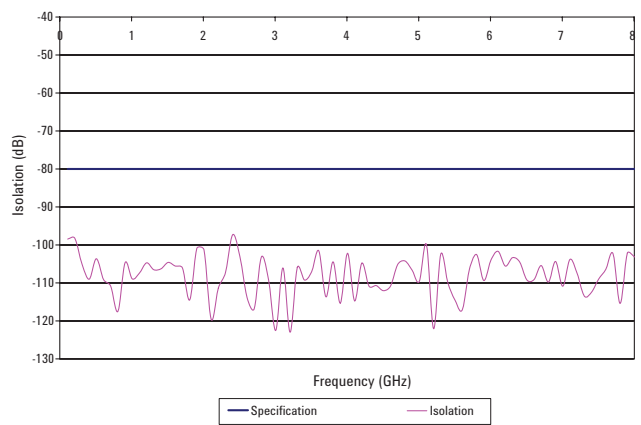

Figure 7. P9402A isolation vs. frequency (typical)

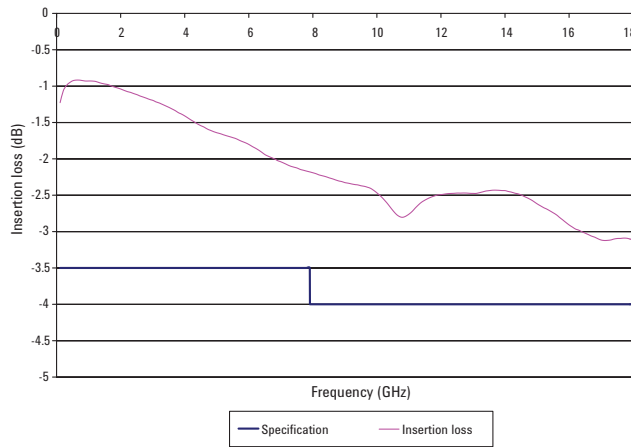

Figure 8. P9402C insertion loss vs. frequency (typical)

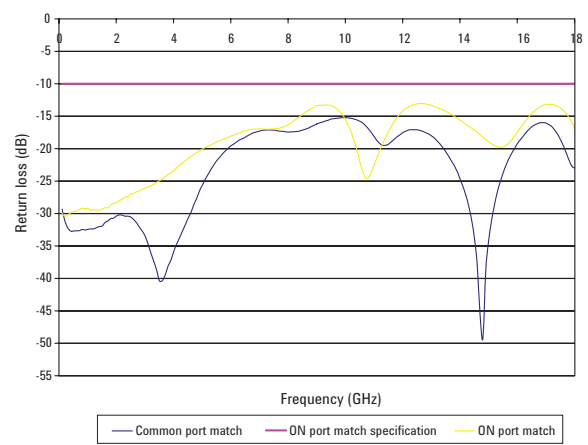

Figure 9. P9402C return loss (ON) vs. frequency (typical)

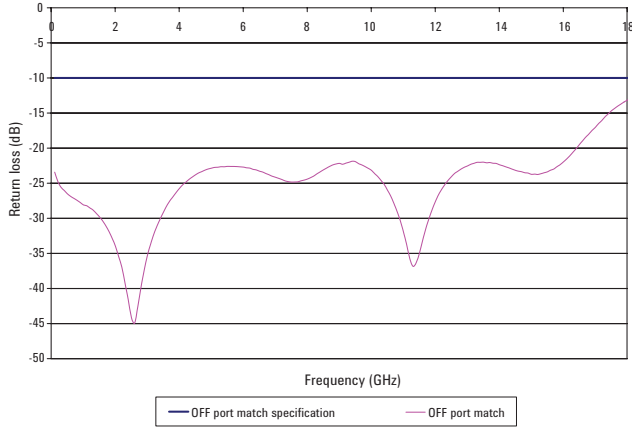

Figure 10. P9402C return loss (OFF) vs. frequency (typical)

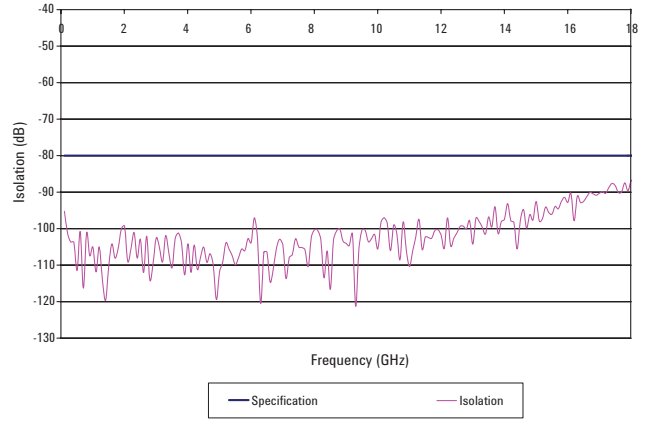

Figure 11. P9402C isolation vs. frequency (typical)

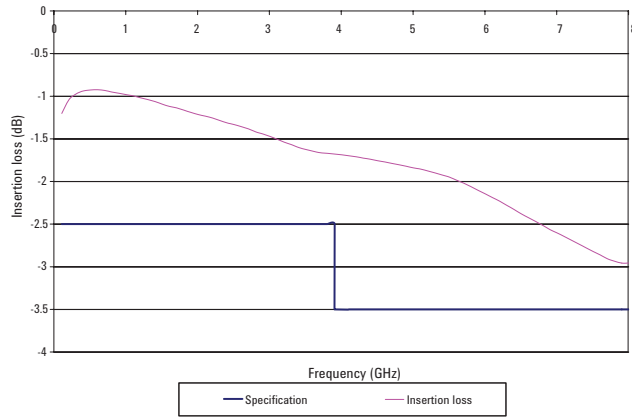

Figure 12. P9404A insertion loss vs. frequency (typical)

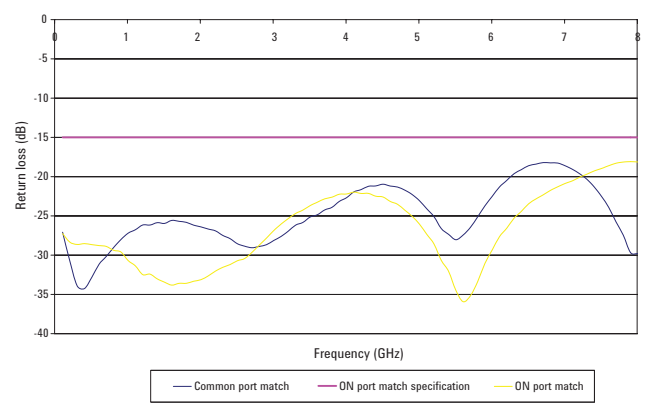

Figure 13. P9404A return loss (ON) vs. frequency (typical)

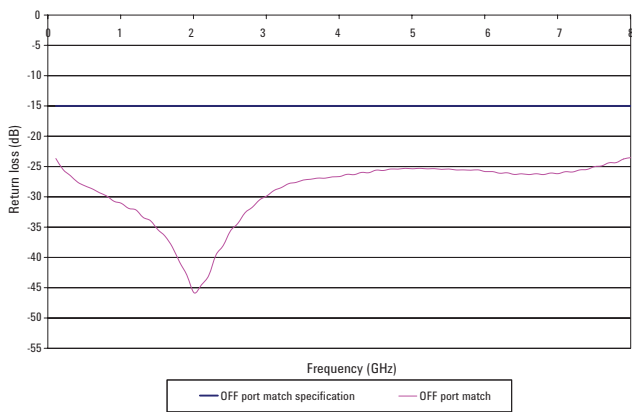

Figure 14. P9404A return loss (OFF) vs. frequency (typical)

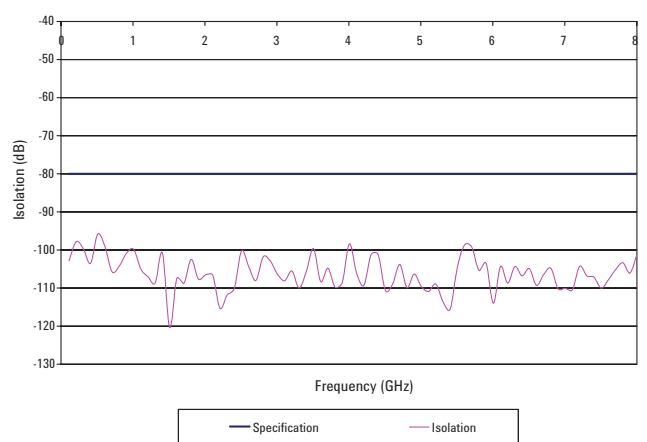

Figure 15. P9404A isolation vs. frequency (typical)

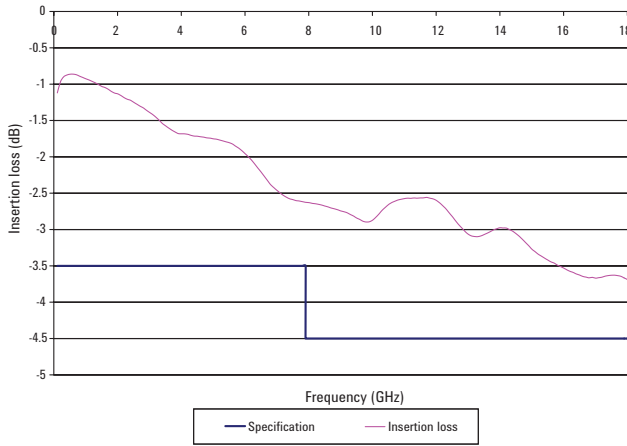

Figure 16. P9404C insertion loss vs. frequency (typical)

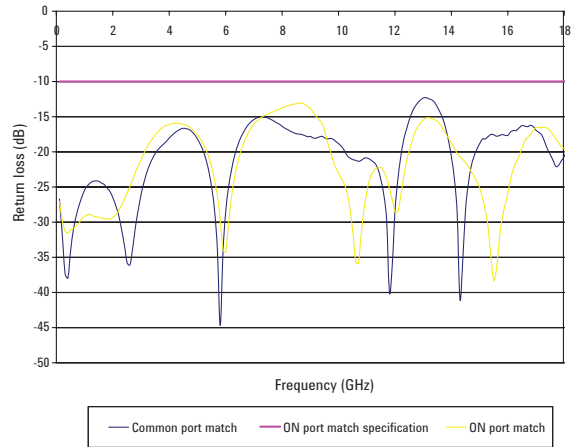

Figure 17. P9404C return loss (ON) vs. frequency (typical)

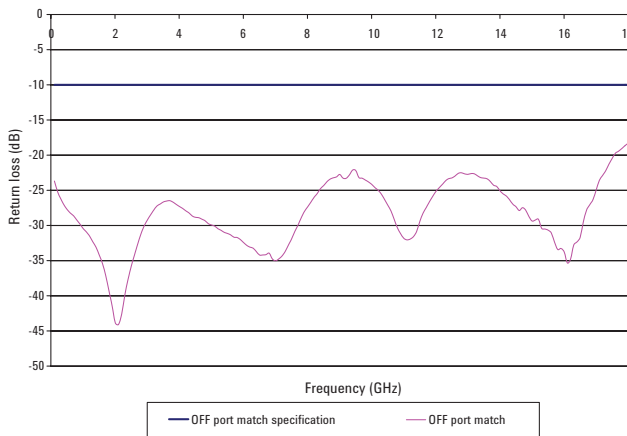

Figure 18. P9404C return loss (OFF) vs. frequency (typical)

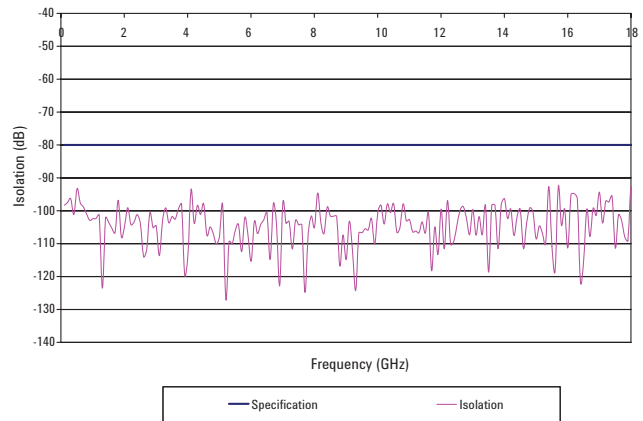

Figure 19. P9404C isolation vs. frequency (typical)

Ordering Information

P9402A 100 MHz to 8 GHz SPDT PIN Switch
 P9402C 100 MHz to 18 GHz SPDT PIN Switch
 P9404A 100 MHz to 8 GHz SP4T PIN Switch
 P9404C 100 MHz to 18 GHz SP4T PIN Switch

www.agilent.com/find/mta

Related Literature

Selecting the right switch technology for your application,
 literature number 5989-5189EN



Agilent Email Updates

www.agilent.com/find/emailupdates

Get the latest information on the products and applications you select.



Agilent Direct

www.agilent.com/find/agilentdirect

Quickly choose and use your test equipment solutions with confidence.

www.agilent.com

For more information on Agilent Technologies' products, applications or services, please contact your local Agilent office. The complete list is available at:

www.agilent.com/find/contactus

Americas

Canada	(877) 894-4414
Latin America	305 269 7500
United States	(800) 829-4444

Asia Pacific

Australia	1 800 629 485
China	800 810 0189
Hong Kong	800 938 693
India	1 800 112 929
Japan	81 426 56 7832
Korea	080 769 0800
Malaysia	1 800 888 848
Singapore	1 800 375 8100
Taiwan	0800 047 866
Thailand	1 800 226 008

Europe

Austria	0820 87 44 11
Belgium	32 (0) 2 404 93 40
Denmark	45 70 13 15 15
Finland	358 (0) 10 855 2100
France	0825 010 700
Germany	01805 24 6333*
	*0.14€/minute
Ireland	1890 924 204
Italy	39 02 92 60 8 484
Netherlands	31 (0) 20 547 2111
Spain	34 (91) 631 3300
Sweden	0200-88 22 55
Switzerland (French)	41 (21) 8113811(Option 2)
Switzerland (German)	0800 80 53 53 (Option 1)
United Kingdom	44 (0) 118 9276201

Other European Countries:

www.agilent.com/find/contactus

Revised: May 7, 2007

Product specifications and descriptions in this document subject to change without notice.

© Agilent Technologies, Inc. 2007

Printed in USA, July 19, 2007

5989-6695EN



Agilent Technologies